

# Owner's Manual

Please read before using this equipment.

## DVD/CD Player with Video Cassette Recorder EWD2004



EMERSON AND THE G-CLEF LOGO ARE REGISTERED TRADEMARKS OF EMERSON RADIO CORP., PARSIPPANY, NEW JERSEY, U.S.A.

INSTRUCCIONES EN ESPAÑOL INCLUIDAS.

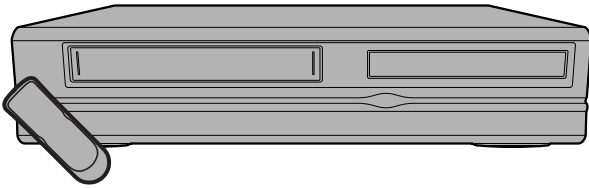

If you need additional operating assistance after reading this owner's manual or to order replacement accessories, please call  
**TOLL FREE : 1-800-256-2487**  
or visit our web site at <http://www.funai-corp.com>

### Supplied Accessory

- Remote control (NB100UD or NB150UD) with two AA batteries
- RF cable (WPZ0901TM002)
- Audio/Video cables (WPZ0102TM015 or WPZ0102LTE01)
- Owner's Manual (1VMN20189)

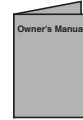
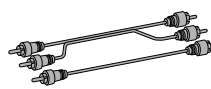
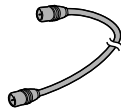
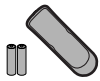

### Table of Contents

<b>Precautions</b>	
Laser Safety	2
■ <b>Important Safeguards</b>	<b>3</b>
Installation Location	4
Avoid the Hazards of Electrical Shock and Fire	4
Moisture Condensation Warning	4
About Copyright	4
Symbol Used in This Manual	4
Maintenance	4
<b>Setup</b>	
■ <b>About the Video Cassettes and Discs</b>	<b>5</b>
Playable Video Cassettes	5
Playable Discs	5
Unplayable Discs	5
■ <b>Connections</b>	<b>5</b>
RF Output Channel	5
Hint for Cable Box or Satellite Box	6
Connection to an Audio System	6
Connection to a TV	7
Front & Rear Terminals	7
■ <b>About the Remote Control and Front Panel</b>	<b>8</b>
■ <b>VCR/DVD Switching</b>	<b>9</b>
■ <b>Preset for Use</b>	<b>10</b>
Turn on the unit for the first time	10
Clock Set Up	10
<b>VCR Functions</b>	
■ <b>Playback</b>	<b>11</b>
■ <b>Recording &amp; OTR (One Touch Recording)</b>	<b>11</b>
■ <b>Other Operations</b>	<b>11</b>
■ <b>On-Screen Operations</b>	<b>12</b>
■ <b>Recording Features</b>	<b>12</b>
Timer Recording	12
Hint for Timer Recording	13
Copying a Video Tape	13
■ <b>Special Features</b>	<b>14</b>
Time Search / Index Search / Auto Repeat	14
<b>DVD Functions</b>	
■ <b>Playback</b>	<b>15</b>
■ <b>The On-Screen Display</b>	<b>16</b>
■ <b>Search Function</b>	<b>17</b>
Track Search / Title/Chapter Search / Time Search	17
■ <b>Marker Setup</b>	<b>17</b>
■ <b>Repeat / Random / Programmed Playback</b>	<b>18</b>
Repeat Playback / Repeat A-B Playback / Random Playback / Programmed Playback	18
■ <b>Special Settings</b>	<b>19</b>
Subtitle Language / Audio Language / Camera Angle / Black Level Setting / Stereo Sound mode / Virtual Surround	19
■ <b>DVD Set Up</b>	<b>20</b>
LANGUAGE Setting	20
DISPLAY Setting	21
AUDIO Setting	21
PARENTAL Setting	22
To return the All Selections of SET UP (except for PARENTAL) to the Default Setting	22
<b>Information</b>	
■ <b>Troubleshooting Guide</b>	<b>23</b>
■ <b>Specifications</b>	<b>24</b>
■ <b>Language List</b>	<b>24</b>
■ <b>Limited Warranty</b>	<b>24</b>
<b>Español</b>	<b>25</b>
<b>Quick Use Guide</b>	<b>27</b>

Precautions  
Setup  
VCR Functions  
DVD Functions  
Information  
Español

### Basic TV Connection / Conexión básica del televisor

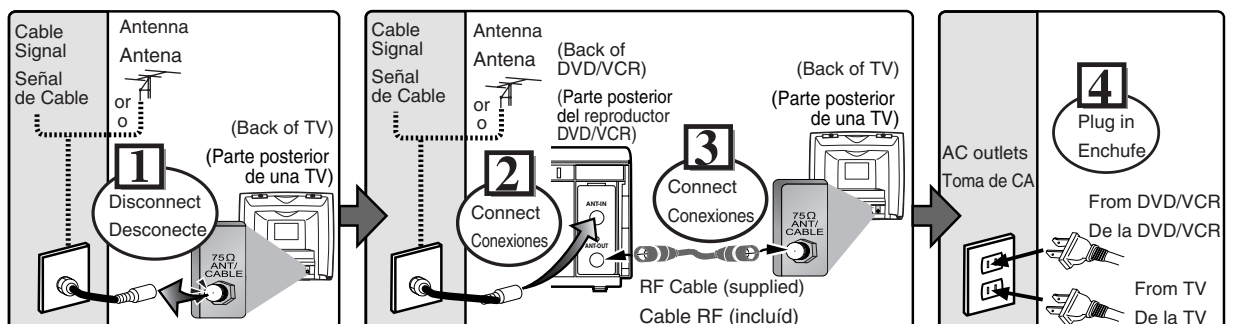

**5** Please refer to "Connections" on page 5.

# Precautions

**WARNING:** TO REDUCE THE RISK OF FIRE OR ELECTRIC SHOCK, DO NOT EXPOSE THIS APPLIANCE TO RAIN OR MOISTURE.



## CAUTION

RISK OF ELECTRIC SHOCK  
DO NOT OPEN



The lightning flash with arrowhead symbol, within an equilateral triangle, is intended to alert the user to the presence of uninsulated "dangerous voltage" within the product's enclosure that may be of sufficient magnitude to constitute a risk of electric shock to persons.



The exclamation point within an equilateral triangle is intended to alert the user to the presence of important operating and maintenance (servicing) instructions in the literature accompanying the appliance.

### CAUTION:

TO REDUCE THE RISK OF ELECTRIC SHOCK, DO NOT REMOVE COVER (OR BACK). NO USER SERVICEABLE PARTS INSIDE. REFER SERVICING TO QUALIFIED SERVICE PERSONNEL.

## Laser Safety

This unit employs a laser. Only a qualified service person should remove the cover or attempt to service this device, due to possible eye injury.

**CAUTION:** USE OF CONTROLS OR ADJUSTMENTS OR PERFORMANCE OF PROCEDURES OTHER THAN THOSE SPECIFIED HEREIN MAY RESULT IN HAZARDOUS RADIATION EXPOSURE.

**CAUTION:** VISIBLE AND INVISIBLE LASER RADIATION WHEN OPEN AND INTERLOCK DEFEATED. DO NOT STARE INTO BEAM.

**LOCATION:** INSIDE, NEAR THE DECK MECHANISM.

**FCC WARNING-** This equipment may generate or use radio frequency energy. Changes or modifications to this equipment may cause harmful interference unless the modifications are expressly approved in the instruction manual. The user could lose the authority to operate this equipment if an unauthorized change or modification is made.

## RADIO-TV INTERFERENCE

This equipment has been tested and found to comply with the limits for a Class B digital device, pursuant to Part 15 of the FCC Rules. These limits are designed to provide reasonable protection against harmful interference in a residential installation. This equipment generates, uses and can radiate radio frequency energy and if not installed and used in accordance with the instructions, may cause harmful interference to radio communications. However, there is no guarantee that interference will not occur in a particular installation. If this equipment does cause harmful interference to radio or television reception, which can be determined by turning the equipment off and on, the user is encouraged to try to correct the interference by one or more of the following measures:

- 1) Reorient or relocate the receiving antenna.
- 2) Increase the separation between the equipment and receiver.
- 3) Connect the equipment into an outlet on a circuit different from that to which the receiver is connected.
- 4) Consult the dealer or an experienced radio/TV technician for help.

**This Class B digital apparatus complies with Canadian ICES-003.**

**Cet appareil numérique de la classe B est conforme à la norme NMB-003 du Canada.**

**CAUTION: TO PREVENT ELECTRIC SHOCK, MATCH WIDE BLADE OF PLUG TO WIDE SLOT, FULLY INSERT.**

**ATTENTION: POUR ÉVITER LES CHOC ÉLECTRIQUES, INTRODUIRE LA LAME LA PLUS LARGE DE LA FICHE DANS LA BORNE CORRESPONDANTE DE LA PRISE ET POUSSER JUSQU'AU FOND.**

## A NOTE ABOUT RECYCLING

This product's packaging materials are recyclable and can be reused. Please dispose of any materials in accordance with your local recycling regulations.

Batteries should never be thrown away or incinerated but disposed of in accordance with your local regulations concerning chemical wastes.

## Make your contribution to the environment!!!

- Used up batteries do not belong in the dust bin.
- You can dispose of them at a collection point for used up batteries or special waste. Contact your council for details.



For Customer Use:

Read carefully the information located at the back of this unit and enter below the Serial No. Retain this information for future reference.

Model No. \_\_\_\_\_

Serial No. \_\_\_\_\_

# Important Safeguards

1. Read Instructions - All the safety and operating instructions should be read before the appliance is operated.
2. Retain Instructions- The safety and operating instructions should be retained for future reference.
3. Heed Warnings - All warnings on the appliance and in the operating instructions should be adhered to.
4. Follow Instructions - All operating and use instructions should be followed.

5. Cleaning - Unplug this video product from the wall outlet before cleaning. Do not use liquid cleaners or aerosol cleaners. Use a damp cloth for cleaning.  
**EXCEPTION:** A product that is meant for uninterrupted service and, that for some specific reason, such as the possibility of the loss of an authorization code for a CATV converter, is not intended to be unplugged by the user for cleaning or any other purpose, may exclude the reference to unplugging the appliance in the cleaning description otherwise required in item 5.

6. Attachments - Do not use attachments not recommended by the video product manufacturer as they may cause hazards.
7. Water and Moisture - Do not use this video product near water, for example, near a bath tub, wash bowl, kitchen sink, or laundry tub, in a wet basement, or near a swimming pool, and the like.
8. Accessories - Do not place this video product on an unstable cart, stand, tripod, bracket, or table. The video product may fall, causing serious injury to a child or adult, and serious damage to the appliance. Use only with a cart, stand, tripod, bracket, or table recommended by the manufacturer, or sold with the video product. Any mounting of the appliance should follow the manufacturer's instructions and should use a mounting accessory recommended by the manufacturer. An appliance and cart combination should be moved with care. Quick stops, excessive force, and uneven surfaces may cause the appliance and cart combination to overturn.

PORTABLE CART WARNING  
 (Symbol provided by RETAC)



S3125A

**MEUBLES - Ne pas installer cet appareil sur un meuble, un socle, un support, un trépied ou une table instables. L'appareil pourrait tomber, provoquant des blessures graves à un enfant ou un adulte, et être sérieusement endommagé. Utiliser uniquement un chariot, un support, un trépied ou une table recommandés par le fabricant, ou bien vendus avec l'appareil. Suivre les directives du fabricant pour le montage de l'appareil et n'utiliser que les accessoires de montage recommandés par ce dernier. Si on l'installe sur un meuble à roulettes, déplacer les deux ensemble avec précaution. Un arrêt brusque, l'utilisation d'une force excessive et des surfaces irrégulières risquent de déstabiliser l'ensemble et de le renverser.**

9. Ventilation - Slots and openings in the cabinet are provided for ventilation and to ensure reliable operation of the video product and to protect it from overheating, and these openings must not be blocked or covered. The openings should never be blocked by placing the video product on a bed, sofa, rug, or other similar surface. This video product should not be placed in a built-in installation such as a bookcase or rack unless proper ventilation is provided or the manufacturer's instructions have been adhered to.
10. Power Sources - This video product should be operated only from the type of power source indicated on the marking label. If you are not sure of the type of power supply to your home, consult your appliance dealer or local power company. For products intended to operate from battery power, or other sources, refer to the operating instructions.
11. Grounding or Polarization - This video product is equipped with a polarized alternating-current line plug (a plug having one blade wider than the other). This plug will fit into the power outlet only one way. This is a safety feature. If you are unable to insert the plug fully into the outlet, try reversing the plug. If the plug should still fail to fit, contact your electrician to replace your obsolete outlet. Do not defeat the safety purpose of the polarized plug.
12. Power Cord Protection - Power supply cords should be routed so that they are not likely to be walked on or pinched by items placed upon or against them, paying particular attention to cords at plugs, convenience receptacles, and the point where

they exit from the appliance.

13. Outdoor Antenna Grounding - If an outside antenna or cable system is connected to the video product, be sure the antenna or cable system is grounded so as to provide some protection against voltage surges and built-up static charges. Article 810 of the National Electrical Code, ANSI/NFPA No. 70, provides information with regard to proper grounding of the mast and supporting structure, grounding of the lead-in wire to an antenna discharge unit, size of grounding conductors, location of antenna-discharge unit, connection to grounding electrodes, and requirements for the grounding electrode. (Fig. A)

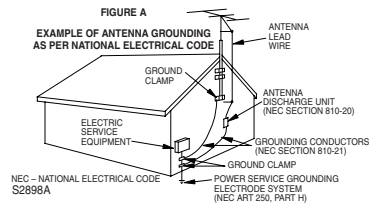

14. Lightning - For added protection for this video product during a lightning storm, or when it is left unattended and unused for long periods of time, unplug it from the wall outlet and disconnect the antenna or cable system. This will prevent damage to the video product due to lightning and power-line surges.
15. Power Lines - An outside antenna system should not be located in the vicinity of overhead power lines or other electric light or power circuits, or where it can fall into such power lines or circuits. When installing an outside antenna system, extreme care should be taken to keep from touching such power lines or circuits as contact with them might be fatal.
16. Overloading - Do not overload wall outlets and extension cords as this can result in a risk of fire or electric shock.
17. Object and Liquid Entry - Never push objects of any kind into this video product through any openings as they may touch dangerous voltage points or short-out parts that could result in a fire or electric shock. Never spill liquid of any kind on the video product.
18. Servicing - Do not attempt to service this video product yourself as opening or removing covers may expose you to dangerous voltage or other hazards. Refer all servicing to qualified service personnel.
19. Damage Requiring Service - Unplug this video product from the wall outlet and refer servicing to qualified service personnel under the following conditions:
  - a. When the power-supply cord or plug is damaged.
  - b. If liquid has been spilled, or objects have fallen into the video product.
  - c. If the video product has been exposed to rain or water.
  - d. If the video product does not operate normally by following the operating instructions. Adjust only those controls that are covered by the operating instructions as an improper adjustment of other controls may result in damage and will often require extensive work by a qualified technician to restore the video product to its normal operation.
  - e. If the video product has been dropped or damaged in any way.
  - f. When the video product exhibits a distinct change in performance this indicates a need for service.
20. Replacement Parts - When replacement parts are required, be sure the service technician has used replacement parts specified by the manufacturer or have the same characteristics as the original part. Unauthorized substitutions may result in fire, electric shock or other hazards.
21. Safety Check - Upon completion of any service or repairs to this video product, ask the service technician to perform safety checks to determine that the video product is in proper operating condition.
22. Heat - This video product should be situated away from heat sources such as radiators, heat registers, stoves, or other products (including amplifiers) that produce heat.

## Installation Location

For safety and optimum performance of this unit:

- Install the unit in a horizontal and stable position. Do not place anything directly on top of the unit. Do not place the unit directly on top of the TV.
- Shield it from direct sunlight and keep it away from sources of intense heat. Avoid dusty or humid places. Avoid places with insufficient ventilation for proper heat dissipation. Do not block the ventilation holes on the sides of the unit. Avoid locations subject to strong vibration or strong magnetic fields.

## Avoid the Hazards of Electrical Shock and Fire

- Do not handle the power cord with wet hands.
- Do not pull on the power cord when disconnecting it from AC wall outlet. Grasp it by the plug.
- If, by accident, water is spilled on this unit, unplug the power cord immediately and take the unit to our Authorized Service Center for servicing.
- Do not put your fingers or objects into the DVD/VCR cassette holder.

## Moisture Condensation Warning

Moisture condensation may occur inside the unit when it is moved from a cold place to a warm place, or after heating a cold room or under conditions of high humidity. Do not use this unit at least for 2 hours until its inside gets dry.

## About Copyright

Unauthorized copying, broadcasting, public performance and lending of discs are prohibited. This product incorporates copyright protection technology that is protected by method claims of certain U.S. patents and other intellectual property rights owned by Macrovision Corporation and other rights owners. Use of this copyright protection technology must be authorized by Macrovision Corporation, and is intended for home and other limited viewing uses only unless otherwise authorized by Macrovision Corporation. Reverse engineering or disassembly is prohibited.

## Symbol Used in This Manual

The following symbols appear in some headings and notes in this manual.



: Description refers to playback or recording of video cassette tapes.



: Description refers to playback of DVD-Video discs.



: Description refers to playback of Audio CDs.

## Maintenance

### SERVICING

- Please refer to relevant topics on the Troubleshooting Guide on page 23 before return the product.
- When this unit become inoperative, do not try to correct the problem by yourself. There are no user-serviceable parts inside. Turn off, unplug the power plug, and please call our help line mentioned on the front page to locate an Authorized Service Center.

### CLEANING THE CABINET

- Use a soft cloth slightly moistened with a mild detergent solution. Do not use a solution containing alcohol, spirits, ammonia or abrasive.

### CLEANING DISCS

- When a disc becomes dirty, clean it with a cleaning cloth. Wipe the disc from the center out. Do not wipe in a circular motion.
- Do not use solvents such as benzine, thinner, commercially available cleaners, detergent, abrasive cleaning agents or antistatic spray intended for analogue records.

### CLEANING THE DISC LENS

- If this unit still does not perform properly although you refer to the relevant sections and to "TROUBLESHOOTING GUIDE" in this Owner's Manual, the laser optical pickup unit may be dirty. Consult your dealer or an Authorized Service Center for inspection and cleaning of the laser optical pickup unit.

### DISC HANDLING

- Handle the discs so that fingerprints and dust do not adhere to the surfaces of the discs.
- Always store the disc in its protective case when it is not used.

### AUTO HEAD CLEANING

- Automatically cleans video heads as you insert or remove a cassette, so you can see a clear picture.
- Playback picture may become blurred or interrupted while the TV program reception is clear. Dirt accumulated on the video heads after a long period of use, or the usage of rental or worn tapes can cause this problem. If a streaky or snowy picture appears during playback, the video heads in your DVD/VCR may need to be cleaned.

1. Please visit your local Audio/Video store and purchase a good quality VHS Video Head Cleaner.
2. If a Video Head Cleaner does not solve the problem, please call our help line mentioned on the front page to locate an Authorized Service Center.

### NOTES:

- Remember to read the instructions along with the video head cleaner before use.
- Clean video heads only when problems occur.

### Note to CATV system installer

This reminder is provided to call the CATV system installer's attention to Article 820-40 of the NEC that provides guidelines for proper grounding and, in particular, specifies that the cable ground should be connected to the grounding system of the building, as close to the point of cable entry as practical.

Manufactured under license from Dolby Laboratories. "Dolby" and the double-D symbol are trademarks of Dolby Laboratories.

# Setup

## About the Video Cassettes and Discs

### Playable Video Cassettes

Use only cassettes marked **VHS** with this unit.

### Playable Discs

Playable discs	Mark (logo)	Region code	Recorded signals	Disc size	Disc types
DVD-Video * 1,2,4,6			Digital video (MPEG2)	12 cm or 8cm	<p><b>Example</b> Title 1   Title 2 Chapter 1   Chapter 2   Chapter 3   Chapter 4   Chapter 1   Chapter 2</p>
DVD-R DVD-RW * 1,2,3,4,5,6		-			
DVD+R DVD+RW * 1,2,3,4,5,6		-			
Audio CD * 4,6		-	Digital audio	12 cm or 8cm	<p><b>Example</b> Track 1   Track 2   Track 3   Track 4   Track 5   Track 6</p>
CD-R CD-RW * 4,5,6					

If you cannot play back a disc which bears one of the marks above, check the following notes.

- \*1: This unit conforms to the NTSC color system. Discs recorded in other color systems such as PAL cannot be played back.
- \*2: Certain DVD-Video discs do not operate as described in this manual due to the intentions of the disc's producers.
- \*3: Only the discs which have been recorded in the video format and finalized can be played back. Discs unfinalized or recorded in the video recording format cannot be played back. Depending on the recording status of a disc, the disc may not be played back at all or normally (the picture or sound may not be smooth, etc.).
- \*4: Scratched or stained discs may not be played back.
- \*5: Some discs cannot be played back because of incompatible recording conditions, characteristics of the recorder or special properties of discs.
- \*6: You can play back discs which bear the marks above. If you use nonstandardized discs, this unit may not play them back. Even if they are played back, the sound or video quality will be compromised.

### Unplayable Discs

- On the following discs, only the sound can be heard (picture cannot be viewed).  
CDV CD-G
- NEVER play back the following discs. Otherwise, malfunction may result!  
DVD-RAM CD-I Photo CD  
Video CD DTS-CD MP3  
DVD with region codes other than 1 or ALL  
DVD-ROM for personal computers  
CD-ROM for personal computers
- On the following disc, the sound MAY NOT be heard.  
Super Audio CD  
Note: Only the sound recorded on the normal CD layer can be delivered.  
The sound recorded on the high density Super Audio CD layer cannot be delivered.
- Any other discs without compatibility indications.

## Connections

Please refer to "Basic TV Connection" on the front page before you use this unit.

### RF Output Channel

If channel 3 is already occupied for broadcasting,

- 1) Set your TV to channel 4.
- 2) Insert a pre-recorded tape into this unit.
- 3) Press the OUTPUT button on the DVD/VCR so that the VCR OUTPUT light is lit.
  - If noise appears on the TV screen, press the VCR/TV button on the remote control.
- 4) Press the PLAY button once.
- 5) After a few seconds, press the PLAY button on the DVD/VCR for 3 seconds.
  - The RF output channel will change to channel 4 from channel 3 and you will see a playback picture.
  - When a picture does not appear on the TV screen, repeat step [4].
- 6) Press the STOP button to stop playback.

#### Hint

- The RF output channel may not change when you adjust tracking during playback. In this case, stop the playback and start the playback again. After that, press the PLAY button on the DVD/VCR for 3 seconds again.



## Hint for Cable Box or Satellite Box

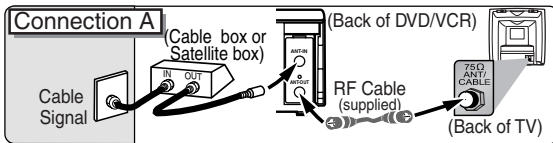

Select this connection when you want to view or record a scrambled channel. With this connection, channels cannot be changed on the DVD/VCR. You can view or record **ONLY** the channels you have selected on the cable box or the satellite box.

- While you are recording, only the recorded channel can be viewed.

### To select channels of the cable box or satellite box

- 1) Turn on the DVD/VCR by pressing the POWER button, and then, press the VCR/TV button. The "POWER" light on the front panel will appear. Then, press the CHANNEL buttons to select channel 3 or 4 (the same channel as the output channel of the cable box or satellite box).
- If you use the channel 4, you need to change the DVD/VCR's RF output to channel 4. Refer to "RF Output Channel".
- 2) At the TV, select channel 3 or 4 (the same channel as you have selected at step 1).
- 3) At the cable box or satellite box, select the channel you want to view or record.

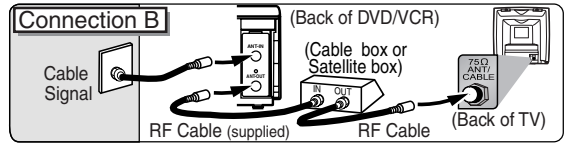

Select this connection when you want to change channels on the DVD/VCR. With this connection, you may watch one channel while recording another.

- You may not view or record a scrambled channel.

### To select channels of the cable box or satellite box

- 1) At the cable box or satellite box, select channel 3 or 4 (the same channel as the DVD/VCR's RF output channel).
- Refer to "RF Output Channel".
- 2) At the TV, select the same channel as the output channel (3 or 4) of the cable box or satellite box.
- 3) Turn on the DVD/VCR by pressing the POWER button, and then, press the VCR/TV button. The "POWER" light on the front panel will appear. Then, select the channel you want to view or record.

### To play back a tape

Follow the steps 1) to 2) above. Then, play back a tape.

- Refer to "Playback" on page 11.

### To view one channel while recording another

- 1) While you are recording on the DVD/VCR, press the VCR/TV button.
- 2) At the cable box or satellite box, select the channel you want to view.

## Connection to an Audio System

### Method 1

#### Stereo system

#### Analog audio input jacks

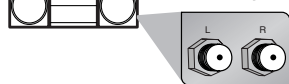

Audio cable (supplied)

#### (Analog) AUDIO OUT

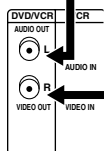

or

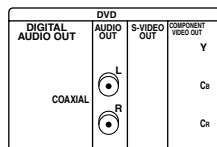

### Method 2

#### Dolby Digital decoder, MD deck or DAT deck

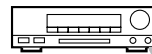

#### Digital audio input jack

Audio Coaxial Digital cable (commercially available)

#### DIGITAL AUDIO OUT

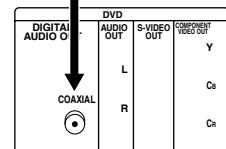

### Note

- If output is Dolby Digital encoded audio, connect to a Dolby Digital decoder, and set "DOLBY DIGITAL" to "ON" in the AUDIO menu. (Refer to pages 20-21.)
- The audio source on a disc in a Dolby Digital 5.1 channel surround format cannot be recorded as digital sound by an MD or DAT deck.
- Unless connected to a Dolby Digital decoder, set "DOLBY DIGITAL" to "OFF" in the AUDIO menu. Playing a DVD using incorrect settings may generate noise distortion, and may also damage the speakers. (Refer to pages 20-21.)
- Set "DOLBY DIGITAL" to "OFF" in the AUDIO menu for connecting to an MD deck or DAT deck. (Refer to pages 20-21.)
- By hooking this unit up to a Multi-channel Dolby Digital decoder, you can enjoy high-quality 5.1ch Dolby Digital surround sound as heard in the movie theaters.

## Connection to a TV

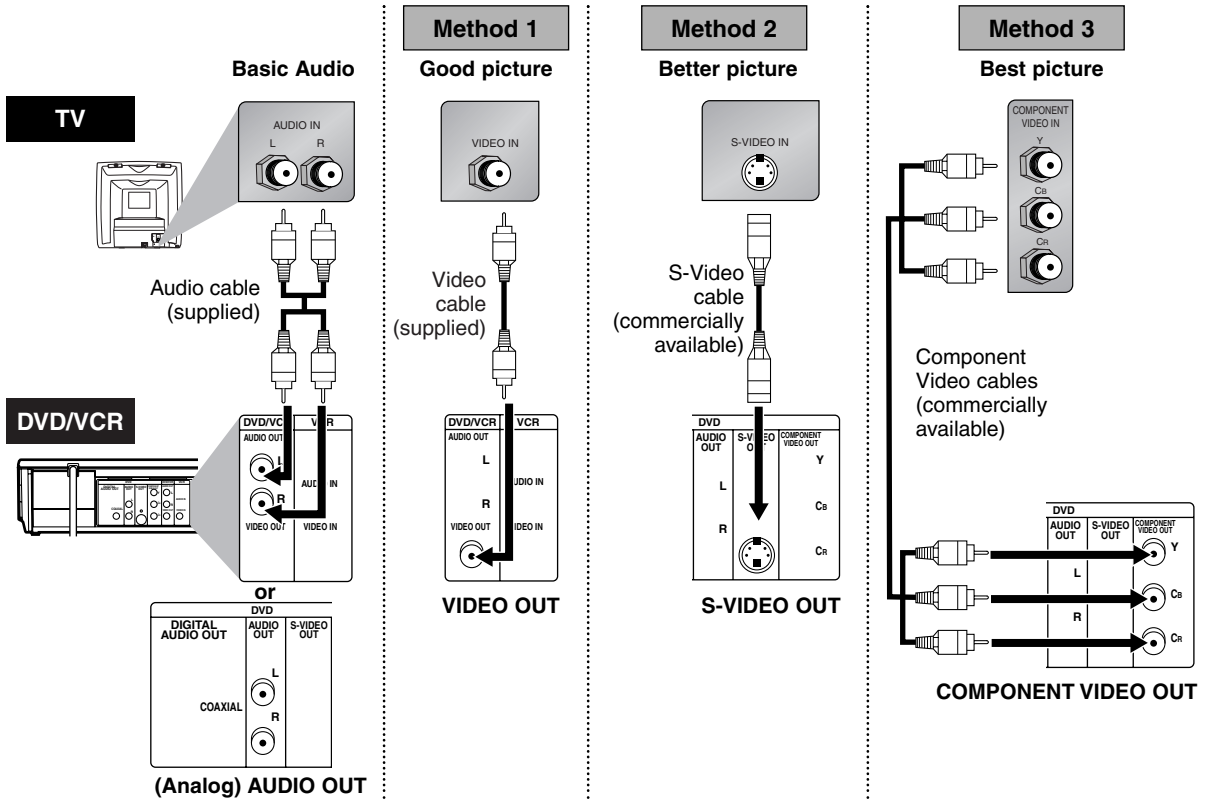

Setup

## Front & Rear Terminals

### DVD ANALOG AUDIO OUT jacks

Connect the supplied audio cables here through the Audio In jacks of a television or other audio equipment. (DVD only)

### COAXIAL jack

Connect an optional coaxial digital audio cable here through the coaxial digital audio in jack of a decoder or audio receiver. (DVD only)

**S-VIDEO OUT jack**  
 Connect an optional S-Video cable here through the S-video in jack of a television. (DVD only)

### DVD/VCR AUDIO OUT jacks

Connect the supplied audio cables here through the audio In jacks of a television or other audio equipment.

**COMPONENT VIDEO OUT jacks**  
 Connect optional component video cables here through the component video in jacks of a television. (DVD only)

**DVD/VCR VIDEO OUT jack**  
 Connect the supplied yellow video cable here through the TV's video in jack.

### AUDIO IN jack

Connect audio cable coming from the audio out jack of a camcorder, another VCR, or an audio source here.

**VIDEO IN jack**  
 Connect a cable coming from the video out jack of a camcorder, another VCR, or an audio-visual source (laser disc player, video disc player, etc.) here.

### ANT IN jack

Connect your antenna or cable box here.

**ANT OUT jack**  
 Connect the supplied RF cable to the antenna input jack on your TV.

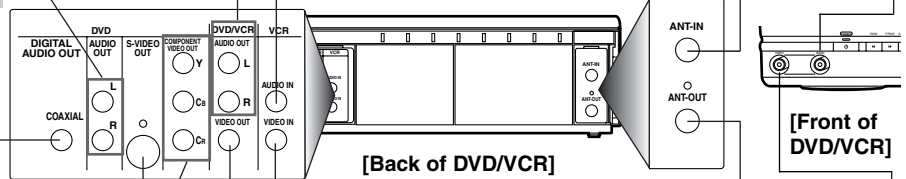

# About the Remote Control and Front Panel

## Remote Control

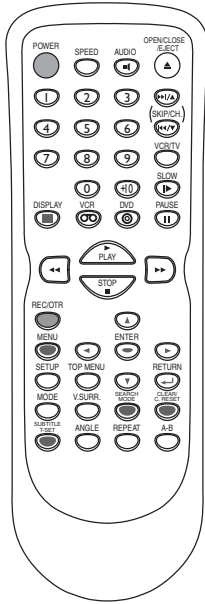

Setup

## Installing the Batteries for the Remote Control

Install two AA batteries (supplied) matching the polarity indicated inside battery compartment of the remote control.

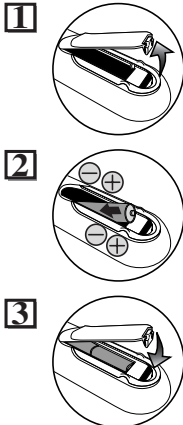

Keep in mind the following when using the remote control:

- Make sure that there is no obstacle between the remote and the remote sensor on the unit.
- Use within the operating range and angle, as shown.

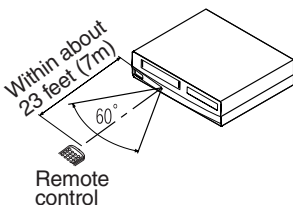

Button (Alphabetical order)	Disc/Tape	DVD mode		VCR mode
1-9, 0		• To select chapter or title directly.	• To select track directly.	• To select channel. • The +10 button has no effect in VCR mode.
◀ ▶		• To search forward/backward through a disc. • To begin slow forward/reverse playback during the pause mode.	• To search forward/backward through a disc.	• To forward/backward a tape.
▲ ▼		• To move the cursor and determine its position.	• To move the cursor and determine its position.	• To select an item on the VCR Menu. • To advance to the next VCR Menu. • To go back one step during clock and timer setting.
A-B		• To repeat between your chosen point A and B.	• To repeat between your chosen point A and B.	—
ANGLE		• To select camera angles on a disc.	—	—
AUDIO		• To select audio languages on a disc.	• To select STEREO, L-CH or R-CH.	—
CLEAR/C RESET		• To clear the markers. • To clear the numbers entered incorrectly.	• To clear the markers. • To remove status No. in program input. • To clear the numbers entered incorrectly.	• To exit the VCR Menu. • To reset the tape counter.
DISPLAY		• To display the current disc mode.	• To display the current disc mode.	• To display the current time, tape counter, and channel.
DVD		• To select the DVD output mode. • To activate the remote control in DVD mode.	• To select the DVD output mode. • To activate the remote control in DVD mode.	—
MENU		• To call up the Menu on a disc.	—	• To call up the VCR Menu.
MODE		• To set black level on/off.	• To arrange the playing order or play randomly.	—
OPEN/CLOSE/EJECT		• To open or close the disc tray.	• To open or close the disc tray.	• To eject the video cassette from the VCR.
PAUSE		• To pause disc playback. • To advance playback one frame at a time.	• To pause disc playback.	• To pause tape playback or recording. • To advance playback one frame at a time.
▶		• To begin disc playback.	• To begin disc playback.	• To begin tape playback.
POWER		• To turn the unit on or off.	• To turn the unit on or off.	• To turn the unit on or off.
REC/OVR		—	—	• To start a recording.
REPEAT		• To play a chapter or title repeatedly.	• To play a track or disc repeatedly.	—
RETURN		• To return to the previous operation on the DVD setup menu.	• To return to the previous operation on the DVD setup menu.	—
SEARCH MODE		• To search chapter, title or time. • To rapidly return to a location of disc. • Search the markers.	• To search track. • To search time. • To rapidly return to a location of disc. • Search the markers.	• To call up the index or time search menu.
SETUP		• To call up the DVD setup menu.	• To call up the DVD setup menu.	—
SKIP/CH. (M/A) SKIP/CH. (M/V)		• To skip chapters.	• To skip tracks.	• To change channels. • To adjust the tracking manually during playback.
SLOW		—	—	• To view the tape in slow motion.
SPEED		—	—	• To select the recording speed.
STOP		• To stop playback.	• To stop playback.	• To stop playback or recording.
SUBTITLE T.SET		• To select subtitles on a disc.	—	• To put the VCR into standby mode for a timer recording.
TOP MENU		• To call up the Top Menu on a disc.	—	—
VCR		—	—	• To select the VCR output mode. • To activate the remote control in VCR mode.
VCR/TV		• To select DVD position or TV position.	• To select CD position or TV position.	• To select VCR position or TV position.
V.SURR.		• To set virtual surround on/off.	• To set virtual surround on/off.	—



## Front Panel Display

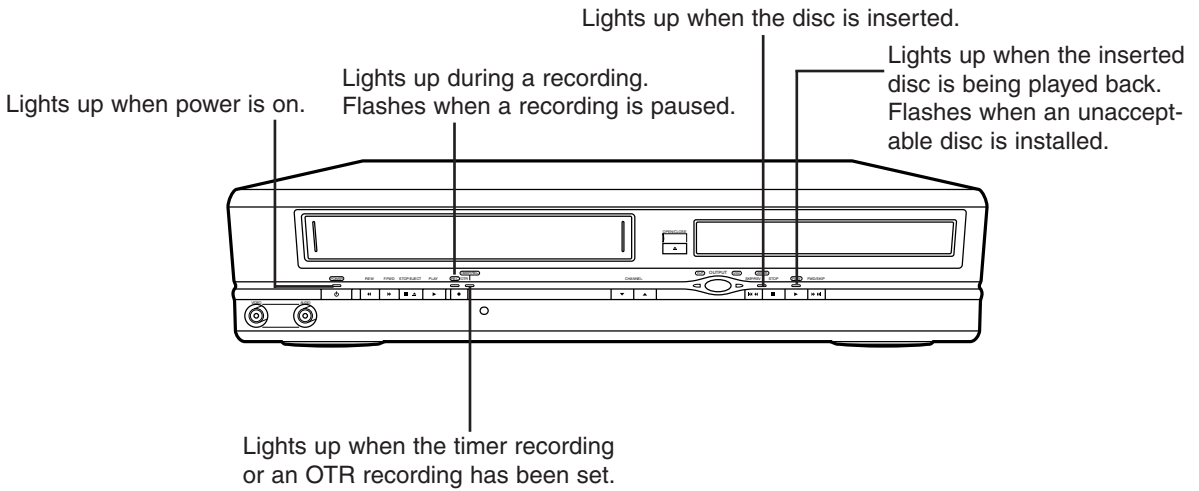

## VCR/DVD Switching

Because this product is a combination of a VCR and a DVD player, you must select first which component you wish to operate with the OUTPUT button.

### VCR MODE

Press the **VCR button** on the remote control.  
(Verify that the VCR OUTPUT light is lit.)

### DVD MODE

Press the **DVD button** on the remote control.  
(Verify that the DVD OUTPUT light is lit.)

#### Note

- Pressing only the **OUTPUT** button on the front panel **DOES NOT** switch the mode of the remote control. You **MUST** select the correct mode on the remote control.

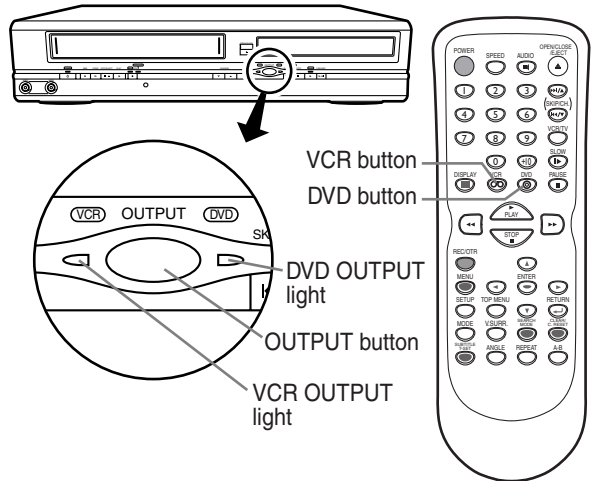

# Preset for Use

## Turn on the unit for the first time



**1** Turn on the TV and set it to channel 3.

- If channel 3 is already occupied for broadcasting, see "RF Output Channel" section.

**2** **POWER** Remote Control TV Screen

LANGUAGE SELECT

- ▶ ENGLISH [ON]
- FRANCAIS
- ESPAÑOL

**3** CH 01

AUTO SET UP

Do you connect the cable from the cable box or the satellite box to the DVD/VCR's ANT IN jack?

**Yes** Press the **MENU** button to exit

- Refer to "Hint for Cable Box or Satellite Box" section on page 6.

**No** Please wait for a few minutes. After scanning...

- The tuner stops on the lowest memorized channel.
- You can select only the channels memorized in this unit by using the CHANNEL buttons.
- If "AUTO SET UP" appears on the TV screen again, check the cable connections. Then press the **▶** button once again.

### Hint

- Repeat these steps only if either there was a power failure or this unit has been unplugged for more than 30 seconds.

### To Select a Channel

You can select a channel by directly entering channel using the Number buttons on the remote control.

### Notes for using the Number buttons:

- When selecting cable channels which are higher than 99, enter channel numbers as a three-digit number. (For example: 117, press 1,1,7)
- You must precede single-digit channel numbers with a zero (For example: 02, 03, 04 and so on).

## To Preset the Channel Again

- 1) Press the **MENU** button until the main menu appears.
- 2) Select "**CHANNEL SET UP**" by pressing the **▲** or **▼** button. Then, press the **▶** button.
- 3) Select "**AUTO SET UP**" by pressing the **▲** or **▼** button. Then, press the **▶** button. After scanning, the tuner stops on the lowest memorized channel.

## To Change the On-Screen Language

- 1) Press the **MENU** button until the main menu appears.
- 2) Select "**LANGUAGE SELECT**" by pressing the **▲** or **▼** button. Then, press the **▶** button.
- 3) Select "**ENGLISH**", "**FRANCAIS**" or "**ESPAÑOL**" by pressing the **▲** or **▼** button. Then, press the **CLEAR/C.RESET** button.

### Hint

- If you accidentally select Spanish or French and need English: Press the **MENU** button and choose **SELEC. IDIOMA**, or **SELECTION LANGUE**. Press the **▶** button, and select **ENGLISH**. Finally, press the **CLEAR/C.RESET** button.

## Clock Set Up



**1** MENU

-MENU-

TIMER PROGRAMMING  
AUTO REPEAT [OFF]  
CHANNEL SET UP  
▶ CLOCK SET  
LANGUAGE SELECT

If the clock is not set, the **CLOCK SET** screen appears when you press the **MENU** button. In this case, go to step [2].

**2** CLOCK SET

MONTH DAY YEAR  
03 / 15 ---

HOUR MINUTE AM/PM  
-- : -- --

Select the current month

**3** CLOCK SET

MONTH DAY YEAR  
03 / 15 3

HOUR MINUTE AM/PM  
-- : -- --

Select the current day

**4** CLOCK SET

MONTH DAY YEAR  
03 / 15 2004

HOUR MINUTE AM/PM  
-- : -- --

Select the current year

**5** CLOCK SET

MONTH DAY YEAR  
03 / 15 MON 2004

HOUR MINUTE AM/PM  
05 : -- --

Select the current hour

**6** CLOCK SET

MONTH DAY YEAR  
03 / 15 MON 2004

HOUR MINUTE AM/PM  
05 : 40 --

Select the current minute

**7** CLOCK SET

MONTH DAY YEAR  
03 / 15 MON 2004

HOUR MINUTE AM/PM  
05 : 40 ▶ M-AM  
▶ P-PM

Select "AM" or "PM"

**8** To exit the **CLOCK SET** screen.

### Hint

- To go back one step, press the **◀** button (during the steps [2] to [7]).
- Your clock setting will be lost if either there is a power failure or this unit has been unplugged for more than 30 seconds.

## Playback

Before:

Turn on the TV and set it to channel 3.

- If channel 3 is already occupied for broadcasting, see "RF Output Channel" section.

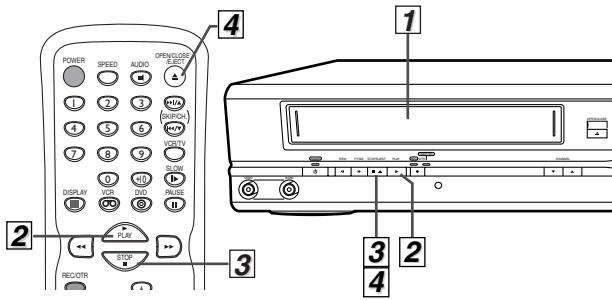
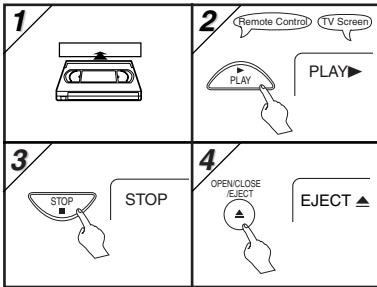

### Hint

- When a tape with-out record tab is inserted, the DVD/VCR will start playback automatically.
- Tracking will be automatically adjusted upon playback. To adjust the tracking manually, press the CHANNEL buttons.

## Recording & OTR (One Touch Recording)

Before:

Turn on the TV and set it to channel 3.

- If channel 3 is already occupied for broadcasting, see "RF Output Channel" section.

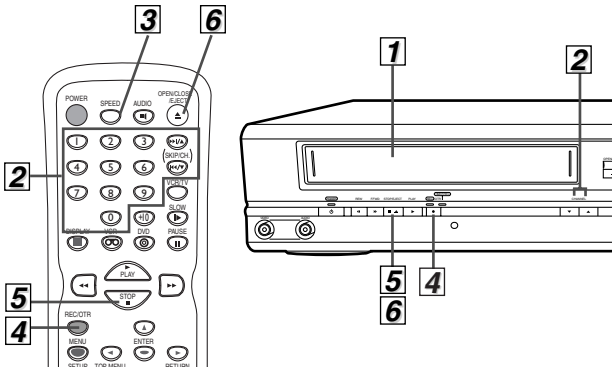
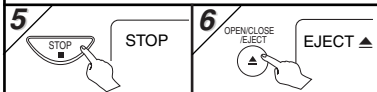
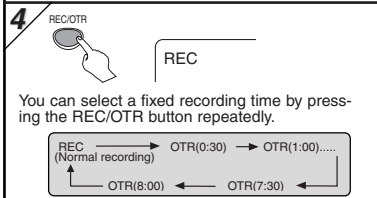
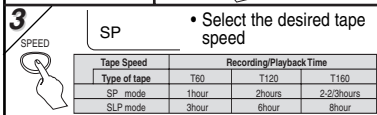
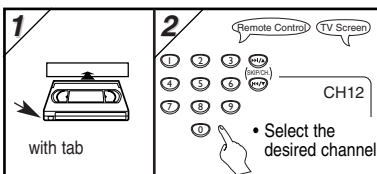

### Hint

- To view one channel while recording another
  - 1) While you are recording on the DVD/VCR, press the VCR/TV button.
  - 2) At the cable box or satellite box, select the channel you want to view.
- If you have connected the DVD/VCR to a cable box or satellite box, refer to "Hint for Cable Box or Satellite Box" section on page 6.

### Accidental erasure prevention

To prevent accidental recording on a recorded cassette, remove its record tab. To record on it later, cover the hole with cellophane tape.

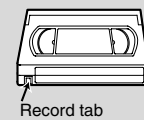

You **CAN NOT** copy a DVD to a videotape.

### To stop recording temporarily (Pause mode)

Press the **PAUSE/STILL** button.

- During the rec-pause mode, five ■ marks appear on the TV screen. Each ■ mark represents one minute.
- Press it again to resume recording.

## Other Operations

### To cue or review picture during playback (Picture Search)

Press the **F.FWD** or **REW** button.

- Press it again and the DVD/VCR will search in super high speed. (in the LP/SLP modes only)

### To freeze the picture on TV screen during playback (Still mode)

Press the **PAUSE/STILL** button. Each time you press the button, the picture will be forwarded by one frame.

- If the picture begins to vibrate vertically during the still mode, stabilize the picture by pressing the CHANNEL buttons.
- If the picture is distorted or rolling vertically, adjust the vertical hold control on your TV, if equipped.

### Counter Reset

Press the **CLEAR/C.RESET** button.

### To play back in slow motion

Press the **SLOW** button during playback or the still mode.

- If the noise bars appear on the TV screen, you can reduce it by pressing the CHANNEL buttons.

### Auto Rewind

When a tape reaches its end during playback, fast-forward, or recording (except timer recording and One Touch Recording), the tape will automatically rewind to the beginning. After rewinding finishes, the DVD/VCR will eject the tape.

### Hint

- Still/Slow/Pause mode will be automatically cancelled after 5 minutes to prevent damage to the tape and the video head.
- To return to playback from the Picture Search/Still/Slow mode, press the PLAY button.

# On-Screen Operations

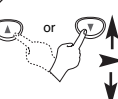
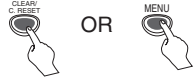

<b>1</b> To call up the main menu  -MENU- ▶ TIMER PROGRAMMING AUTO REPEAT [OFF] CHANNEL SET UP CLOCK SET LANGUAGE SELECT	<b>3</b> To decide CHANNEL SET UP AUTO SET UP ▶ MANUAL SET UP
<b>2</b> To select an item  -MENU- TIMER PROGRAMMING AUTO REPEAT [OFF] ▶ CHANNEL SET UP CLOCK SET LANGUAGE SELECT	<b>4</b> To exit the menu 

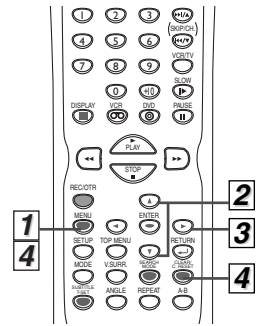

## Recording Features

### Timer Recording

• Insert a tape with its record tab into the DVD/VCR.



<b>1</b> -MENU- ▶ TIMER PROGRAMMING AUTO REPEAT [OFF] CHANNEL SET UP CLOCK SET LANGUAGE SELECT
<b>2</b> PROGRAM NUMBER 4 DATE ---:---:--- START TIME ---:---:--- END TIME ---:---:--- CHANNEL --- REC SPEED --- Select an empty program number
<b>3</b> PROGRAM NUMBER 4 ▶ ONCE DAILY WEEKLY Select "ONCE", "DAILY" (Mon-Fri), or "WEEKLY"
<b>4</b> Select the desired month ONE TIME PROGRAM PROGRAM NUMBER 4 DATE 05/03 MON START TIME 07:30 PM END TIME ---:---:--- CHANNEL --- REC SPEED --- Select the desired day • You can program one year in advance.

<b>5</b> Select the desired start time (hour) ONE TIME PROGRAM PROGRAM NUMBER 4 DATE 05/03 MON START TIME 07:30 PM END TIME ---:---:--- CHANNEL --- REC SPEED --- Select the minute
<b>6</b> ONE TIME PROGRAM PROGRAM NUMBER 4 DATE 05/03 MON START TIME 07:30 PM END TIME ---:---:--- CHANNEL --- REC SPEED --- Select "AM" or "PM"
<b>7</b> Repeat the procedure in steps 5 and 6 to set the end time.
<b>8</b> ONE TIME PROGRAM PROGRAM NUMBER 4 DATE 05/03 MON START TIME 07:30 PM END TIME 08:30 PM CHANNEL 16 REC SPEED 16 Select the desired channel • If you have connected the DVD/VCR to a cable box or satellite box as the Connection A on page 6, select the VCR to channel 3 or 4 (the RF output channel of the VCR). Then select the desired channel at the cable box or satellite box. Leave the cable box or satellite box on for timer recording.

<b>9</b> ONE TIME PROGRAM PROGRAM NUMBER 4 DATE 05/03 MON START TIME 07:30 PM END TIME 08:30 PM CHANNEL 16 REC SPEED 16 Select the desired recording speed • To set another program after step [9], press the ► button. Then continue with step [2].
<b>10</b> • TIMER REC light on the front panel appears. The DVD/VCR will change to the DVD mode.
<b>Hint</b> • To go back one step, press the ◀ button (during the steps [3] to [9].)
<b>To Check, Correct, or Cancel a Timer Program</b>
<ol style="list-style-type: none"> <li>1) Press the SUBTITLE/T-SET button then the VCR button on the remote control.</li> <li>2) Select main menu by pressing the MENU button.</li> <li>3) Select "TIMER PROGRAMMING" by pressing the ▲ or ▼ button. Then press the ► button.</li> <li>4) Select the program number which you want to check by pressing the ▲ or ▼ button. The details of the program you selected will appear on the TV screen.           <ul style="list-style-type: none"> <li>• Go to the digit you want to change by pressing the ► or ◀ button. Then enter correct numbers by pressing the ▲ or ▼ button.</li> <li>• You may cancel the entire program by pressing the ◀ button while the program number flashes.</li> </ul> </li> <li>5) Press the CLEAR/C.RESET button to exit.</li> <li>6) Press the SUBTITLE/T-SET button to return to timer stand-by mode.</li> </ol>
<b>To cancel a Timer Recording in progress</b> Press the STOP/EJECT button on the DVD/VCR.

## Hint for Timer Recording

- If there is a power failure or the DVD/VCR has been unplugged for more than 30 seconds, the clock setting and all timer settings will be lost.
- If a tape is not in the DVD/VCR or does not have the record tab, the TIMER REC light flashes and timer recording cannot be performed. Please insert a recordable tape.
- If a tape ends during timer recording, the VCR will stop, eject the tape and switch to the DVD mode automatically as the TIMER REC light flashes. (If the DVD power is off, the VCR will become STANDBY status.)
- When all timer recordings are finished, the TIMER REC light will flash.
- **When timer recordings are set, the TIMER REC light will appear. To use the VCR as usual until the time for the recording, press the SUBTITLE/T-SET button so that the TIMER REC light disappears. Press the VCR/TV button to choose the VCR position. Select either VCR or DVD mode, then continue with the other features as described in this manual.**

If you want to use the DVD player during a VCR timer recording or while the TIMER REC light is on or flashes.

- You can use the DVD player while the TIMER REC light is on or flashes, or during a timer recording. Press the POWER button to turn on the DVD. Press the DVD button on the remote control to choose DVD mode, then continue with the other DVD features as described in this manual. You don't have to set the TIMER off to use the DVD only.

## Copying a Video Tape

**Warning:** Unauthorized recordings of copyrighted video tapes may be an infringement of copyright laws.

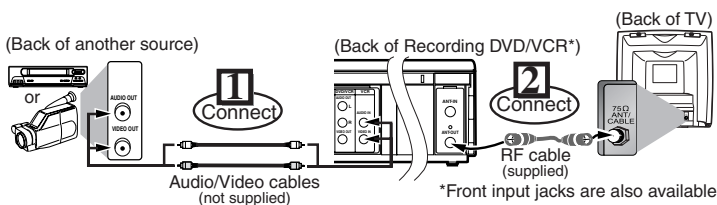

### Hint

- For best results during dubbing, use the front panel controls whenever possible. The remote control might affect another source's operation.
- Always use video-quality shielded cables with RCA-type connectors. Standard audio cables are not recommended.
- You can use a video disc player, satellite receiver or other audio/video component with A/V outputs.
- "L1" or "L2" is found before the lowest memorized channel. (Example: CH02)
- "L2" input jacks are on the front of this DVD/VCR.

- 1) Insert a pre-recorded tape into the playing VCR.
- 2) Insert a tape with its record tab into the recording DVD/VCR.
- 3) Press the **SPEED** button on the remote control of the recording DVD/VCR to select the desired recording speed (SP/SLP).
- 4) Select the "L1" or "L2" position on the recording DVD/VCR.
  - To use the input jacks on the back of this unit, select "L1" position by pressing [0], [0], [1] on the remote control or the **CHANNEL** buttons.
  - To use the input jacks on the front of this unit, select "L2" position by pressing [0], [0], [2] on the remote control or the **CHANNEL** buttons.
- 5) Press the **REC/OTR** button on the recording DVD/VCR.
- 6) Begin playback of the tape in another source.
- 7) To stop recording, press the **STOP/EJECT** button on the recording DVD/VCR, then stop playback of the tape in another source.



# Special Features

## Time Search

You can specify the time for fast forwarding or rewinding.

- Insert a tape into this unit.

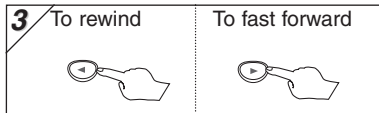
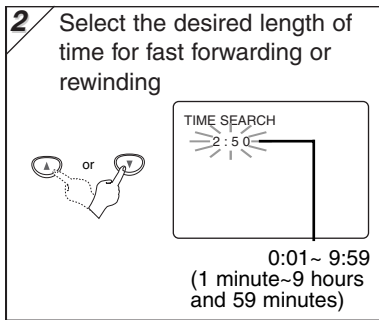
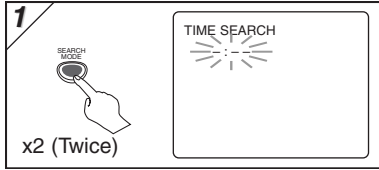

After searching,

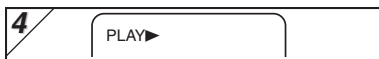

## Index Search

You can specify the number of programs to be skipped.

- Insert a tape into this unit.

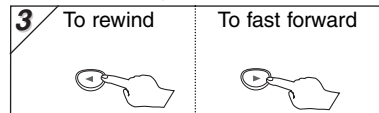
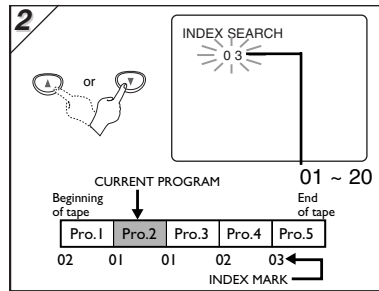

After searching,



### Hint

- This unit stores index mark at the beginning of the recording. There should be time gap between two index marks for the Index Search.

## Auto Repeat

You can repeat playback of a whole tape automatically.

- Insert a tape into this unit.

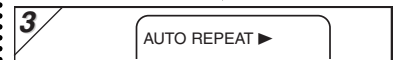
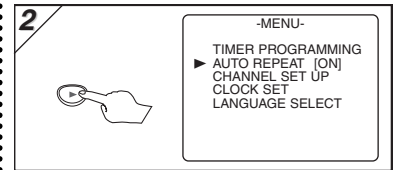
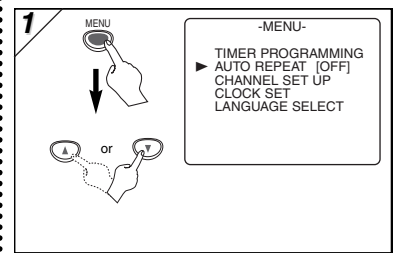

### Hint

- To cancel Auto Repeat, follow steps [1]-[2] above. Then press the right arrow button, so that [OFF] appears beside AUTO REPEAT. Press the CLEAR/C.RESET button to exit.
- If menu remains on the TV screen at step [3], press the CLEAR/C.RESET button to exit.

## Hint for Timer Search & Index Search

- These functions are not available during recording.
- Press the STOP button to stop the search.
- If the end of the tape is reached during a Search, this unit will cancel the search and rewind the tape.

## Playback

Before: Turn on the TV, amplifier and any other components which are connected to this unit. Make sure the TV and audio receiver (commercially available) are set to the correct channel.

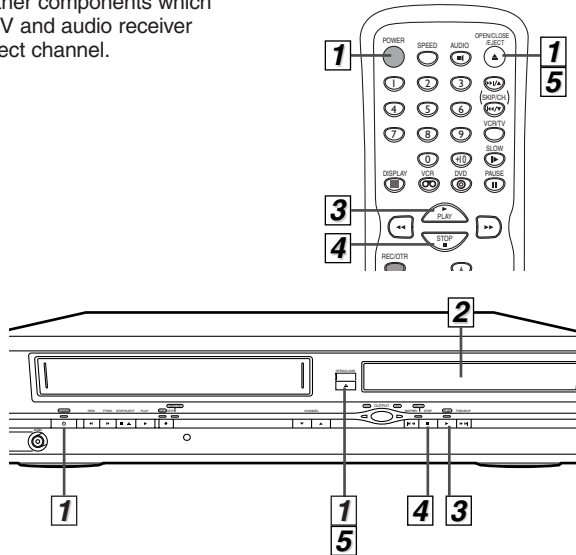
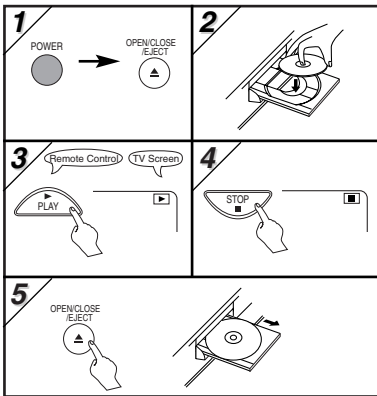

### Hint

- A "prohibited icon" may appear at the top-right on the TV screen when the operation is prohibited by the disc or this unit.
- Some DVDs may be played from title 2 or 3 due to specific programs.
- During the playback of a two-layered disc, pictures may stop for a moment. This happens while the 1st layer is being switched to the 2nd layer. This is not a malfunction.

### DVD menu

DVDs may contain menus to access special features. Press appropriate Number buttons or use the arrow (▲/▼/◀/▶) buttons to highlight your selection on the DVD main menu and press the ENTER button to confirm.

### Calling up a Menu Screen during Playback

- Press the MENU button to call up the DVD menu.
- Press the TOP MENU button to call up the title menu.

Note

- Menu operations may vary depending on the disc. Refer to the manual accompanying the disc for details.

### Resume



Press the **STOP** button. Resume message will appear on the TV screen.

Press the **PLAY** button, playback will resume from the point at which playback was stopped.

- To cancel resume, press the **STOP** button one more time during the Stop mode.

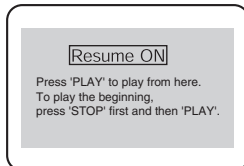

### Paused and Step-by-Step Playback



Press the **PAUSE** button during playback. To continue playback, press the **PLAY** button.



The disc goes forward by one frame each time the **PAUSE** button is pressed during the pause mode. To continue playback, press the **PLAY** button.

### Hint

- Set "STILL MODE" to "FIELD" in the Display menu if pictures in the pause mode are blurred. (Refer to pages 20-21.)

### To use the SKIP/REV, FWD/SKIP buttons on the Main Unit



Press once to skip chapters or tracks to a desired point. Press and hold to change forward or reverse playback speed.

### Fast Forward/Reverse Search



Press the **▶▶** or **◀◀** button repeatedly during playback to select the required forward or reverse speed.

To continue playback, press the **PLAY** button.

- For DVDs, fast forward or reverse search speed is different depending on the disc. Approximate speed is 1 (x2), 2 (x8), 3 (x50), 4 (x100).
- For Audio CDs, approximate speed is x16.

### Slow Forward/Slow Reverse



Press the **▶▶** or **◀◀** button repeatedly during the pause mode to select the required forward or reverse speed.

To continue playback, press the **PLAY** button.

- Slow forward or reverse speed is different depending on the disc. Approximate speed is 1 (1/16), 2 (1/8), 3 (1/2).

### Hint

- Set "STILL MODE" to "FIELD" in the Display menu if pictures in the slow playback mode are blurred. (Refer to pages 20-21.)

# The On-Screen Display

You can check the information about the current disc by pressing the DISPLAY button on the remote control.

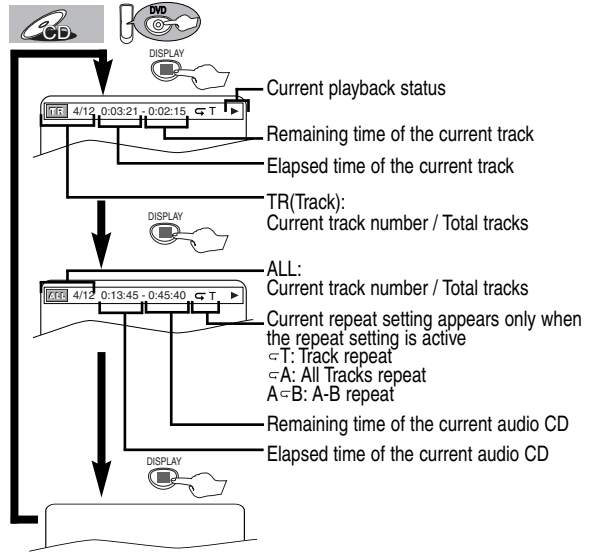
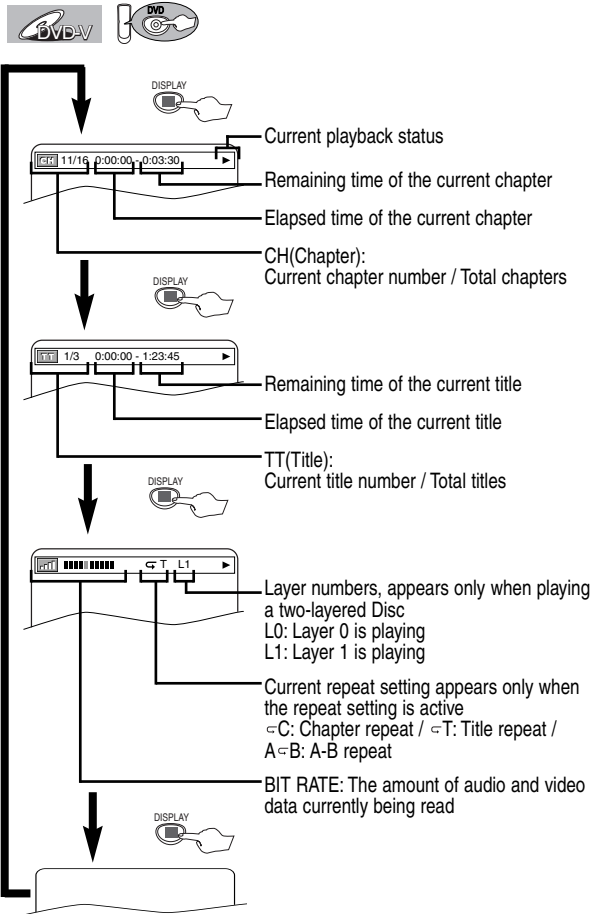

# Search Function

## Track Search



### Using the number buttons

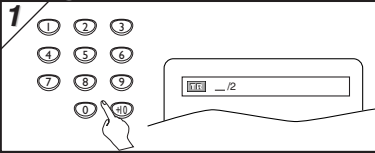

- For single digit tracks (1-9), press a single number (eg. track 3, press 3).
- To play track 26, press +10, 2, 6 of the Number buttons.

### Using the SEARCH MODE button

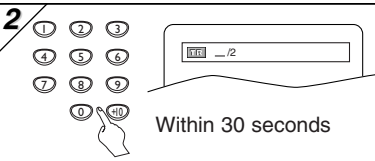
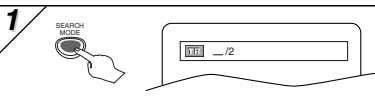

### Using the SKIP <<, >> buttons

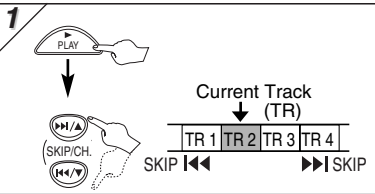

## Title / Chapter Search



### Using the SEARCH MODE button

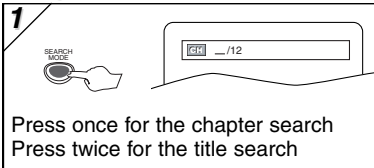

Press once for the chapter search  
Press twice for the title search

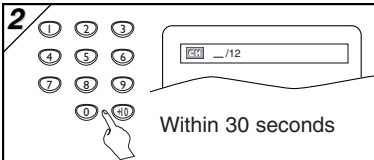

Within 30 seconds

### Using the SKIP <<, >> buttons

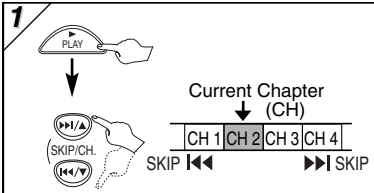

#### Note

- Depending on the disc being played, this function can also be performed by directly entering the desired chapter number with the number buttons. Refer to the manual accompanying the disc.

## Time Search

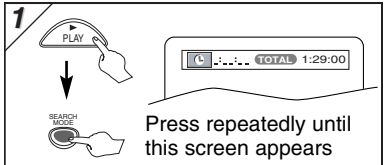

Press repeatedly until this screen appears

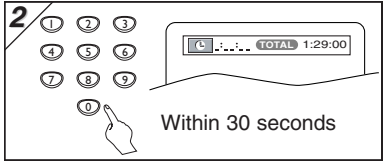

Within 30 seconds

- For Time Search, "0" appears automatically when there is no need to enter a number. For example, "0:0:\_" appears in the Time Search screen if the total time of the disc is less than 10 minutes.

# Marker Setup



This feature allows you to assign a specific point on a disc to be called back later.

### To set a marker

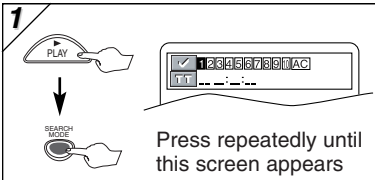

Press repeatedly until this screen appears

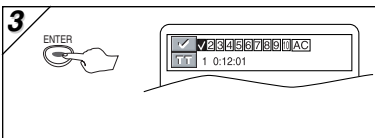
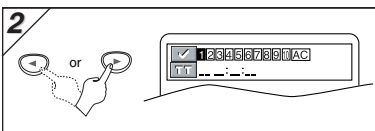

### To return to the marker later

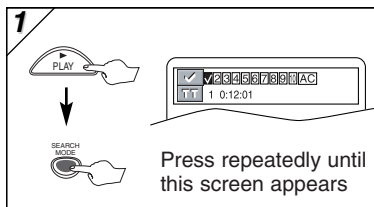

Press repeatedly until this screen appears

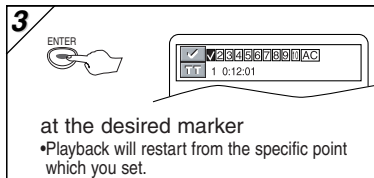
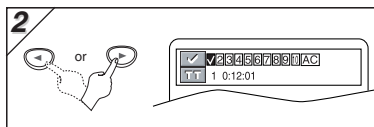

at the desired marker

- Playback will restart from the specific point which you set.

### To exit the marker screen

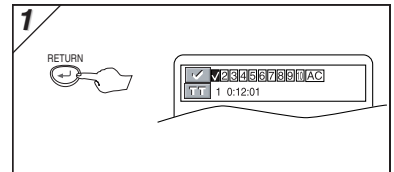

#### Notes

- Opening the disc tray or turning off the power will erase all markers.
- Selecting "AC" at step [2] in the section "To set a marker" will also erase all markers.
- To clear a marker, select the marker to be cleared at step [2] and then press the CLEAR/C.RESET button.

# Repeat / Random / Programmed Playback

## Repeat Playback



Repeat function is available only during playback.

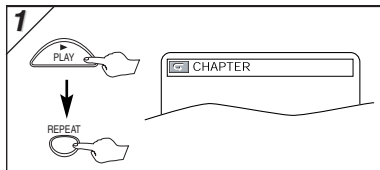

Each time the REPEAT button is pressed...



- ▶ **CHAPTER** (current chapter repeat)
- ▶ **TITLE** (current title repeat)
- ▶ **OFF** (repeat off)



- ▶ **TRACK** (current track repeat)
- ▶ **ALL** (entire disc repeat)
- ▶ **OFF** (repeat off)

- Repeat setting will be cleared when moving to another title, chapter, or track.
- Repeat playback are not available with all discs or during repeat A-B playback.

## Repeat A-B Playback

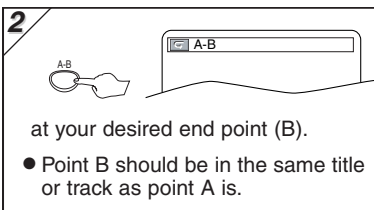
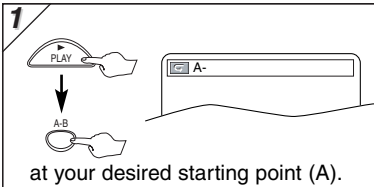

- To exit the sequence, press the A-B button.
- To cancel Point A, press the CLEAR/C.RESET button.
- This function does not work in the other repeat modes.

## Random Playback

This shuffles the playing order of tracks instead of playback in the sequence.

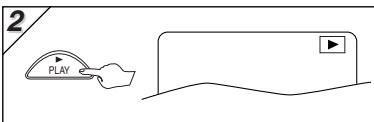
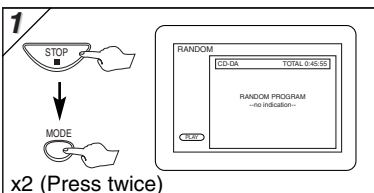

### Note

- If you want to repeat the current track in the random selections, press the REPEAT button repeatedly until "▶ TRACK" appears during playback. If you want to repeat the entire random selections, press the REPEAT button repeatedly until "▶ ALL" appears during playback.

## Programmed Playback



You may determine the order in which tracks will play.

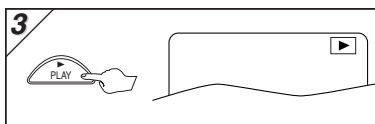
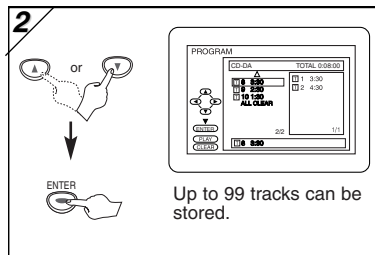
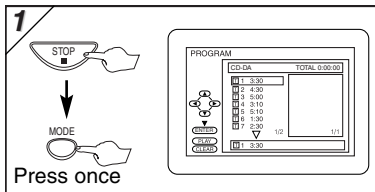

### Notes

- Press the CLEAR/C.RESET button at step [2] to erase the most recently entered program.
- To erase all tracks in the program at once, select "ALL CLEAR" and press the ENTER button at step [2].
- While a program is being played back, the STOP button works as follows;
  - ⇒ Press the STOP button and the PLAY button next, so that the programmed playback restarts. (CD playback restarts from the current point.)
  - ⇒ Press the STOP button twice and the PLAY button next, so that playback restarts from the first track in the original order. However, your programmed playback can be restarted when you follow the above steps. (Your program is still stored until either the disc tray is open or power is turned off.)
- To repeat the current track in the program, press the REPEAT button repeatedly until "▶ TRACK" appears during playback.
- To repeat the entire program press the REPEAT button repeatedly until "▶ ALL" appears during playback.



# Special Settings

## Subtitle Language



This unit allows you to select a subtitle language (if available) during DVD playback.

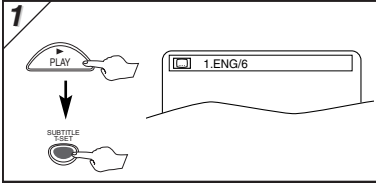

Each time you press the SUBTITLE/T-SET button, subtitle languages change.

### For example

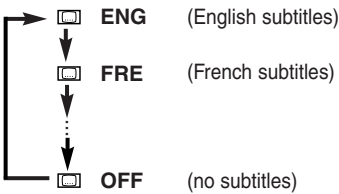

### To set subtitle ON/OFF

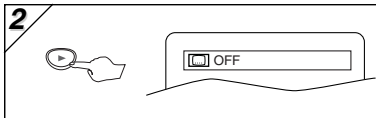
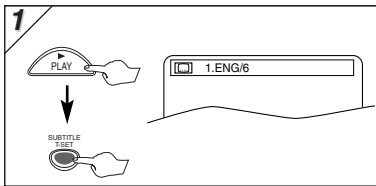

### Notes

- If your language is not shown after pressing the AUDIO or SUBTITLE/T-SET button several times, the disc may not have that language. However, some discs allow audio language or subtitle language setting on the disc menu. (Operation varies depending on the discs, so refer to the manual along with the disc.)
- When "NOT AVAILABLE" appears on the TV screen, it means no subtitle is recorded on the scene.
- If you choose a language that has a 3 letter language code, the code will be displayed every time you change the subtitle language setting. If you choose any other languages, '---' will be displayed instead. (Refer to page 24.)

## Audio Language



This unit allows you to select an audio language (if multiple languages are available) during DVD playback.

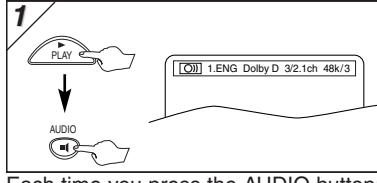

Each time you press the AUDIO button;

### For example

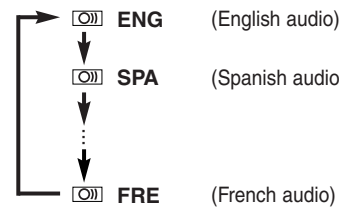

## Camera Angle



Some DVD discs may contain scenes which have been shot simultaneously from various angles. You can change the camera angle if the (ANGLE) icon appears on the screen. If the "ANGLE ICON" setting is "OFF" in the Display menu, the (ANGLE) icon will not appear. (Refer to pages 20-21.)

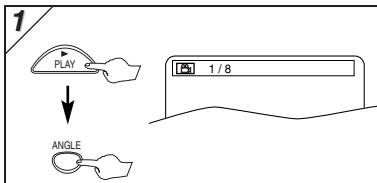

## Black Level Setting



Adjust the Black Level Setting to make the dark areas of the TV picture brighter.

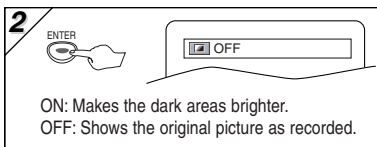
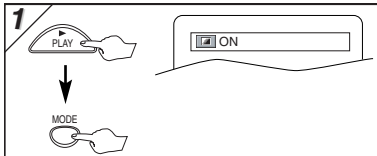

## Stereo Sound mode



This unit allows you to select a sound mode during CD playback.

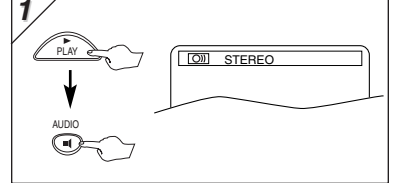

Each time you press the AUDIO button;

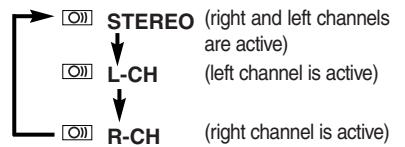

### Note

- If the Virtual Surround setting is "1" or "2", the sound mode will be fixed to STEREO, and can not be changed.

## Virtual Surround



You can enjoy surround-sound effect over two speakers of your own.

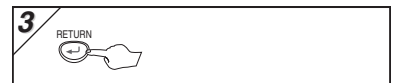
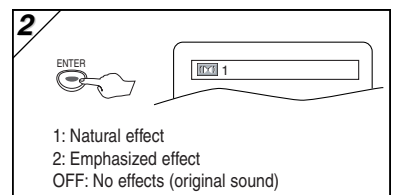
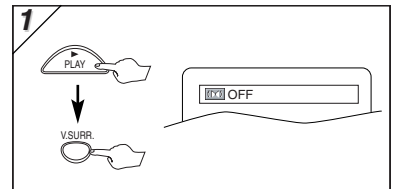

### Note (for CD play back only)

- Virtual Surround will not be effective if the sound mode is set to something other than STEREO.

DVD Functions

## QUICK SETUP Menu

You can select the "PLAYER MENU", "TV ASPECT", or "DOLBY DIGITAL" from the QUICK SETUP menu quickly.

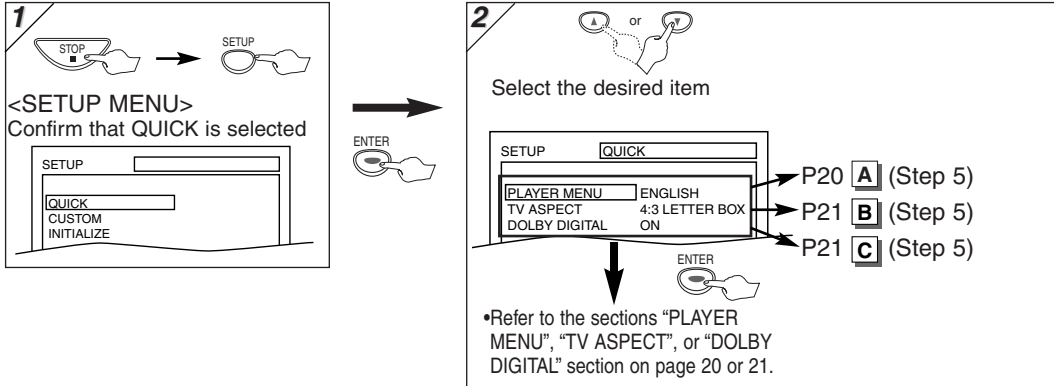

## CUSTOM Menu

You can change the DVD player's settings.

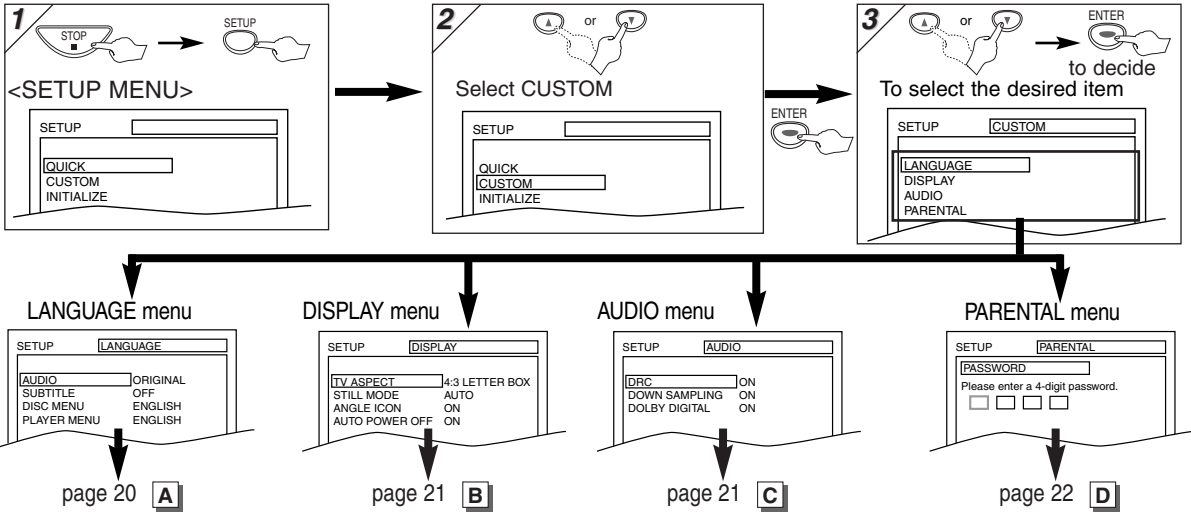

## A LANGUAGE Setting

Follow the step 1) to 3) in the "CUSTOM Menu" section above.

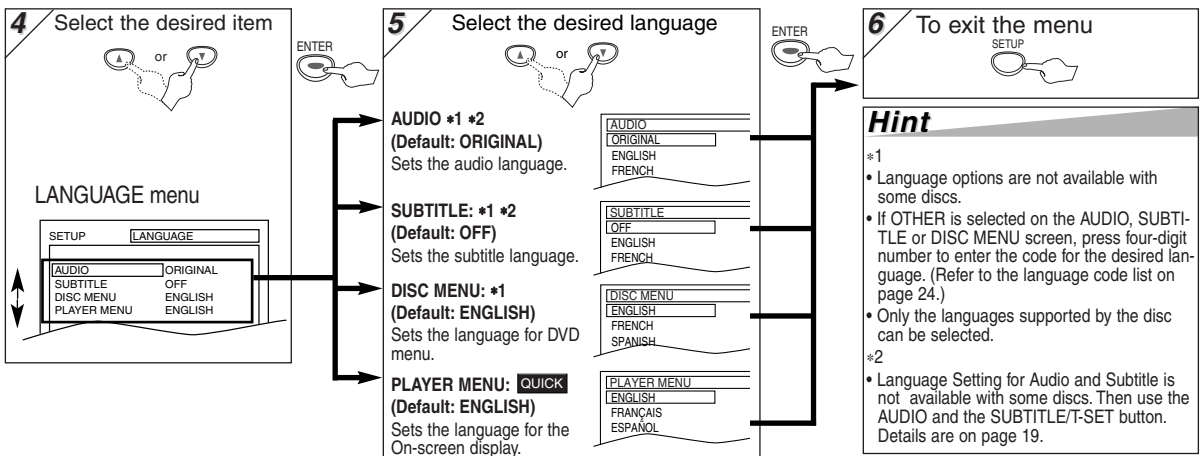

## B DISPLAY Setting

You can change the display functions. Follow the step 1) to 3) in the "CUSTOM Menu" section on page 20.

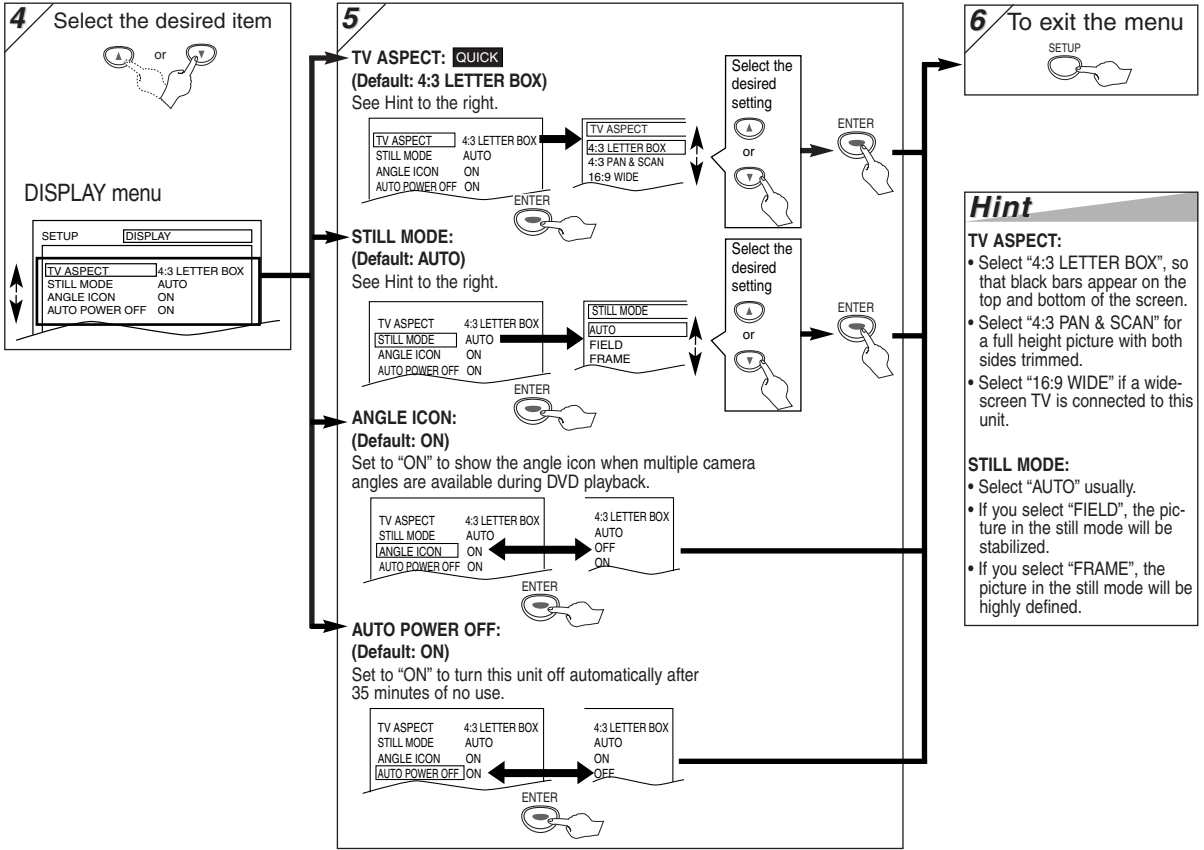

## C AUDIO Setting

Choose the appropriate audio settings for your equipment. It only affects during the playback of DVD discs. Follow the step 1) to 3) in the "CUSTOM Menu" section on page 20.

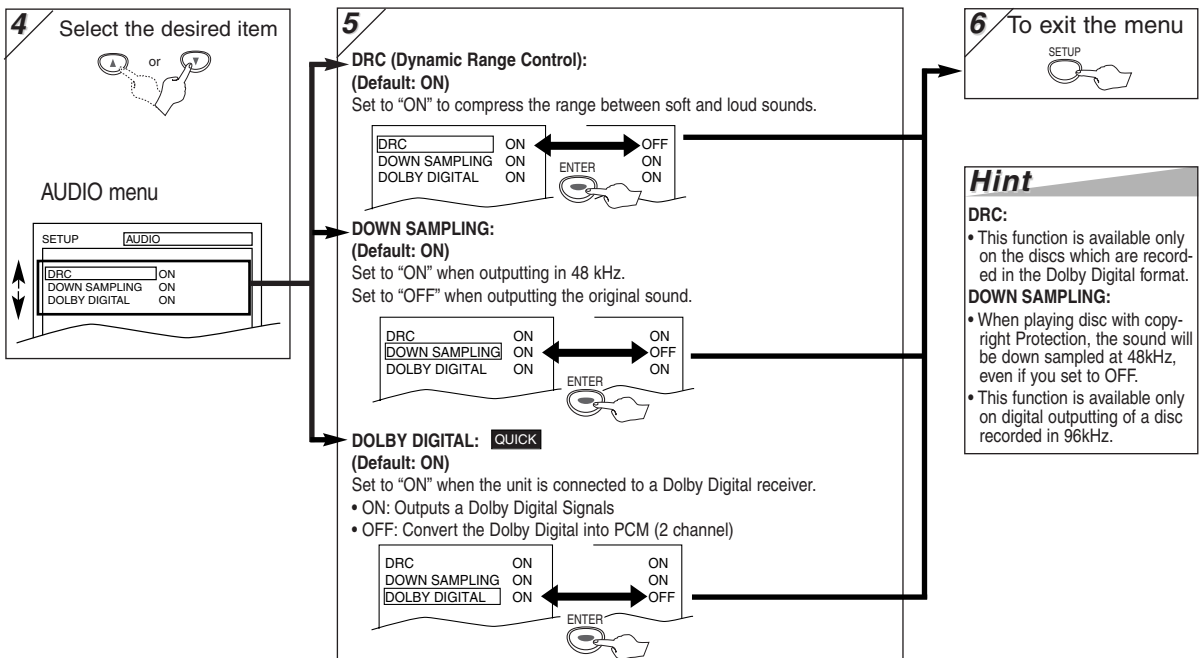

DVD Functions

## D PARENTAL Setting

Parental Control limits the disc viewing that exceed your settings. (an incorrect password will not play.) This feature prevents your children from viewing inappropriate materials.

### Parental Levels

Parental Level allows you to set the rating levels of your DVD discs. Playback will stop if the ratings exceed the levels you set. Follow the steps 1) to 3) in the "CUSTOM Menu" section on page 20.

**4** Enter your desired four-digit password (except for 4737)

PARENTAL menu

..... or .....

If you have set a password already, enter the current four-digit password.

**5** Select "PARENTAL LEVEL"

**6** Select the desired levels

**7** To exit the menu

**Hint**

**CONTROL LEVELS**

- ALL: All parental locks are cancelled.
- Level 8: DVD softwares of any grades (adult/general/children) can be played back.
- Levels 7 to 2: Only DVD softwares intended for general use and children can be played back.
- Level 1: Only DVD softwares intended for children can be played back, with those intended for adult and general use prohibited.

### To Change the Password for Parental Controls

You can change your password for parental controls. Follow the steps 1) to 3) in the "CUSTOM Menu" section on page 20.

**4** Enter your desired four-digit password (except for 4737)

PARENTAL menu

**5** Select "CHANGE"

**6** Enter your new four-digit password (except for 4737)

**7** To exit the menu

**Hint**

- Record the password in case you forget it.
- If you forget the password, press 4, 7, 3, 7 at step 4, then enter your new password.
- Password will be cleared and parental levels will be set to ALL.

### To return the All Selections of SET UP (except for PARENTAL) to the Default Setting

**1**

<SETUP MENU>

**2**

Select INITIALIZE

**3**

Select "YES"

**4** To exit the menu

**Hint**

- When you cancel to initialize at step 3, select "NO".

## Troubleshooting Guide

If this unit does not perform properly when operated as instructed in this Owner's Manual, check this unit consulting the following checklist.

	PROBLEM	CORRECTIVE ACTION
<b>D V D</b>	No power.	<ul style="list-style-type: none"> <li>• Make sure the power plug is connected to an AC outlet.</li> <li>• Make sure the power is turned on.</li> </ul>
	<b>V C R</b>	This unit does not respond to the remote control.
<b>V C R</b>		Timer recording is impossible.
	Cannot go into Record mode.	<ul style="list-style-type: none"> <li>• Make sure the tape has a safety tab. If needed, cover the hole with cellophane tape.</li> <li>• Activate your radio to an empty AM station so that you hear a lot of noises. Turn the volume up, then. If you hear some signal sound from the radio in response to your pressing buttons on the remote, the remote control is working.</li> </ul>
	Playback picture is partially noisy.	<ul style="list-style-type: none"> <li>• Adjust tracking control for a better picture by pressing the CHANNEL (▲/▼) buttons on the DVD/VCR or the SKIP/CH.(▲/▼) buttons on the remote control.</li> </ul>
	Cannot view a tape but the audio is OK.	<ul style="list-style-type: none"> <li>• Head cleaning may be necessary. Refer to "AUTO HEAD CLEANING".</li> <li>• Make sure the VCR is not in the Menu mode.</li> </ul>
	No, or poor, playback picture.	<ul style="list-style-type: none"> <li>• Change the RF output channel to CH4. Then select the same channel on the TV.</li> <li>• Fine tune your TV.</li> </ul>
	TV programs cannot be seen normally.	<ul style="list-style-type: none"> <li>• Re-check the ANT. IN and ANT. OUT connections. See the front page and page 6.</li> <li>• Press the VCR/TV button.</li> <li>• Press the VCR button on the remote control to activate it in the VCR mode. Check if the green VCR OUTPUT light is lit. Then, set it to the TV position by pressing the VCR/TV button.</li> </ul>
	Video or color fades in and out when making a copy of a video tape.	<ul style="list-style-type: none"> <li>• You cannot copy a copyrighted video tape. You are experiencing copy guard protection.</li> </ul>
Cannot remove the tape.	<ul style="list-style-type: none"> <li>• Check if this unit is in the VCR mode. If not, press the VCR button on the remote control to switch the mode.</li> </ul>	
<b>D V D</b>	No picture.	<ul style="list-style-type: none"> <li>• Connect the video cables firmly.</li> <li>• Insert a correct video disc that plays on this unit.</li> <li>• Press the DVD button on the remote control. Check if the DVD OUTPUT light is lit. Then try other DVD features.</li> </ul>
	Disc cannot be played.	<ul style="list-style-type: none"> <li>• Insert the disc.</li> <li>• Clean the disc.</li> <li>• Place the disc correctly with the label side up.</li> <li>• Cancel the parental lock or change the control levels.</li> <li>• Handle a disc with special care so that it does not have fingerprints, scratches, or dusts on its surface.</li> </ul>
	No sound.	<ul style="list-style-type: none"> <li>• Connect the audio cables firmly.</li> <li>• Turn the power of the audio component on.</li> <li>• Correct the audio output settings.</li> <li>• Correct the input settings on the audio component.</li> </ul>
	No DTS audio is output.	<ul style="list-style-type: none"> <li>• This unit does not support DTS audio. This is not a malfunction.</li> </ul>
	Distorted picture.	<ul style="list-style-type: none"> <li>• Connect this unit directly to the TV.</li> <li>• There are some cases where pictures may be slightly distorted, and those are not a sign of a malfunction.</li> <li>• Although pictures may stop for a moment, this is not a malfunction.</li> </ul>
	Audio or subtitle language does not match the set up.	<ul style="list-style-type: none"> <li>• The selected language is not available for audio or subtitles on the DVD. This is not a malfunction.</li> </ul>
	The camera angle cannot be changed.	<ul style="list-style-type: none"> <li>• The DVD does not contain sequences recorded from different camera angles. This is not a malfunction.</li> </ul>
	Audio or subtitle language cannot be changed.	<ul style="list-style-type: none"> <li>• The DVD does not contain audio source or subtitles in the selected language. This is not a malfunction.</li> </ul>
	"Prohibited icon" appears on the screen, prohibiting an operation	<ul style="list-style-type: none"> <li>• That operation is prohibited by this unit or the disc. This is not a malfunction.</li> </ul>

- Some functions are not available in specific modes, but this is not a malfunction. Read the description in this Owner's Manual for details on correct operations.
- Playback from a desired track and random playback are not available during program playback.
- Some functions are prohibited on some discs.



# Specifications

## Video Heads :

Four Heads

## Output signal format :

NTSC color

## Power source :

120 V AC +/- 10%, 60 Hz +/- 0.5%

## Power consumption :

21 W (standby: 3.6W)

## Operating temperature :

41°F (5°C) to 104°F (40°C)

## Dimensions :

W : 17 3/16" (435mm)

H : 3 3/4" (94mm)

D : 9 3/16" (233mm)

## Weight :

Approx 6lbs (2.7kg)

• Designs and specifications are subject to change without notice.

• If there is a discrepancy between languages, the default language will be English.

# Language List

Language	Code	Language	Code	Language	Code	Language	Code
Abkhazian	A-B	French [FRE]	5264	Macedonian	5957	Siswat	6565
Afar	4747	Frisian	5271	Malagasy	5953	Slovak	6557
Afrikaans	4752	Galician	5358	Malay	5965	Slovenian	6558
Albanian	6563	Georgian	5747	Malayalam	5958	Somali	6561
Amharic	4759	German [GER]	5051	Maltese	5966	Spanish [SPA]	5165
Arabic	4764	Greek [GRE]	5158	Maori	5955	Sundanese	6567
Armenian	5471	Greenlandic	5758	Marathi	5964	Swahili	6569
Assamese	4765	Guarani	5360	Moldavian	5961	Swedish [SWE]	6568
Aymara	4771	Gujarati	5367	Mongolian	5960		
Azerbaijani	4772	Hausa	5447	Nauru	6047	Tagalog	6658
Bashkir	4847	Hebrew	5569	Nepali	6051	Tajik	6653
Basque	5167	Hindi	5455	Norwegian [NOR]	6061	Tamil	6647
Bengali;Bangla	4860	Hungarian [HUN]	5467			Tatar	6666
Bhutani	5072			Occitan	6149	Telugu	6651
Bihari	4854	Icelandic [ICE]	5565	Oriya	6164	Thai	6654
Bislama	4855	Indonesian	5560	Oromo(Afan)	6159	Tibetan	4861
Breton	4864	Interlingue	5547	Panjabi	6247	Tigrinya	6655
Bulgarian	4853	Interlingue	5551	Pashto;Pushto	6265	Tonga	6661
Burmese	5971	Inupiak	5557	Persian	6247	Tsonga	6665
Byelorussian	4851	Irish [IRI]	5347	Polish	6258	Turkish [TUR]	6664
		Italian [ITA]	5566	Portuguese [POR]	6266	Turkmen	6657
		Japanese [JPN]	5647	Quechua	6367	Twi	6669
		Javanese	5669	Rhaeto-Romance	6459		
		Kannada	5760	Romanian [RUM]	6461	Ukrainian	6757
		Kashmiri	5765	Russian [RUS]	6467	Urdu	6764
		Kazakh	5757			Uzbek	6772
		Kinyarwanda	6469	Samoan	6559	Vietnamese	6855
		Kirghiz	5771	Sangho	6553	Volapuk	6861
		Kirundi	6460	Sanskrit	6547	Welsh	4971
		Korean [KOR]	5761	Scots Gaelic	5350	Wolof	6961
		Kurdish	5767	Serbian	6564	Xhosa	7054
				Serbo-Croatian	6554	Yiddish	5655
		Laothian	5861	Sesotho	6566	Yoruba	7161
		Latin	5847	Setswana	6660	Zulu	7267
		Latvian;Lettish	5868	Shona	6560		
		Lingala	5860	Sindhi	6550		
		Lithuanian	5866	Singhalese	6555		

If you choose a Language that has a 3 letter language code, the code will be displayed every time you change the Audio or Subtitle language setting on page 19. If you choose any other languages, '---' will be displayed instead. (3 letter language code is written in bracket.)

## Emerson Limited Warranty

FUNAI CORP. will repair this Emerson product, free of charge in the USA in the event of defect in materials or workmanship as follows:

### DURATION:

#### PARTS:

FUNAI CORP. will provide parts to replace defective parts without charge for one (1) year from the date of original retail purchase. Two (2) years for Picture Tube. Certain parts are excluded from this warranty.

#### LABOR:

FUNAI CORP. will provide the labor without charge for a period of ninety (90) days from the date of original retail purchase.

### LIMITS AND EXCLUSIONS:

THIS WARRANTY IS EXTENDED ONLY TO THE ORIGINAL RETAIL PURCHASER. A PURCHASE RECEIPT OR OTHER PROOF OF ORIGINAL RETAIL PURCHASE WILL BE REQUIRED TOGETHER WITH THE PRODUCT TO OBTAIN SERVICE UNDER THIS WARRANTY.

This warranty shall not be extended to any other person or transferee.

This warranty is void and of no effect if any serial numbers on the product are altered, replaced, defaced, missing or if service was attempted by an unauthorized service center. This Emerson Limited warranty does not apply to any product not purchased and used in the United States.

This warranty only covers failures due to defects in material or workmanship which occurs during normal use. It does not cover damage which occurs in shipment, or failures which are caused by repairs, alterations or product not supplied by FUNAI CORP., or damage which results from accident, misuse, abuse, mishandling, misapplication, alteration, faulty installation, improper maintenance, commercial use such as hotel, rental or office use of this product or damage which results from fire, flood, lightning or other acts of God.

THIS WARRANTY DOES NOT COVER PACKING MATERIALS, ANY ACCESSORIES (EXCEPT REMOTE CONTROL), ANY COSMETIC PARTS, COMPLETE ASSEMBLY PARTS, DEMO OR FLOOR MODELS.

FUNAI CORP. AND ITS REPRESENTATIVES OR AGENTS SHALL IN NO

EVENT BE LIABLE FOR ANY GENERAL, INDIRECT OR CONSEQUENTIAL DAMAGES ARISING OUT OF OR OCCASIONED BY THE USE OF OR THE INABILITY TO USE THIS PRODUCT. THIS WARRANTY IS MADE IN LIEU OF ALL OTHER WARRANTIES, EXPRESS OR IMPLIED, AND OF ALL OTHER LIABILITIES ON THE PART OF FUNAI. ALL OTHER WARRANTIES INCLUDING THE WARRANTY OF MERCHANTABILITY, AND FITNESS FOR A PARTICULAR PURPOSE, ARE HEREBY DISCLAIMED BY FUNAI AND ITS REPRESENTATIVES IN THE UNITED STATES.

ALL WARRANTY INSPECTIONS AND REPAIRS MUST BE PERFORMED BY A FUNAI AUTHORIZED SERVICE CENTER. THIS WARRANTY IS VALID WHEN THE UNIT IS CARRIED-IN TO FUNAI AUTHORIZED SERVICE FACILITY.

### IMPORTANT:

THIS LIMITED WARRANTY GIVES YOU SPECIFIC LEGAL RIGHTS. YOU MAY HAVE OTHER RIGHTS THAT VARY FROM STATE TO STATE. IF, AT ANY TIME DURING THE WARRANTY PERIOD, YOU ARE UNABLE TO OBTAIN SATISFACTION WITH THE REPAIR OF THIS PRODUCT, PLEASE CONTACT FUNAI CORP.

### ATTENTION:

FUNAI CORP. RESERVES THE RIGHT TO MODIFY ANY DESIGN OF THIS PRODUCT WITHOUT PRIOR NOTICE.

To locate your nearest Emerson Authorized Service Center or for general service procedure, please call 1-800-256-2487 or write to the following:

**FUNAI CORPORATION, INC.  
SERVICE CENTER**

19900 Van Ness Avenue, Torrance, CA 90501

Tel : 1-800-256-2487

<http://www.funai-corp.com>

Head Office: 100 North Street, Teterboro, NJ 07608

PLEASE DO NOT SHIP YOUR UNIT TO THE TETERBORO ADDRESS.

## 1 Conexiones

Consulte la "Conexión básica del televisor" en la página delantera antes de utilizar esta unidad.

### Canal de salida RF

Si el canal 3 se está utilizando para una transmisión.

- 1) Programe su televisor al canal 4.
- 2) Inserte una cinta pregrabada en esta unidad.
- 3) Pulse el botón OUTPUT en el DVD/VCR para que se encienda la luz VCR OUTPUT.
  - Si aparecen ruidos en la pantalla del televisor, pulse el botón VCR/TV en el mando a distancia.
- 4) Pulse una vez el botón PLAY.
- 5) Después de unos segundos, pulse el botón PLAY en el DVD/VCR durante 3 segundos.
  - El canal de salida RF cambiará del canal 3 al canal 4 y podrá ver una imagen reproducida.
  - Cuando no aparezca una imagen en la pantalla del televisor, repita el paso (4).
- 6) Pulse el botón STOP para parar la reproducción.

## 2 Instalación de las pilas del mando a distancia



## 3 Conmutación VCR/DVD

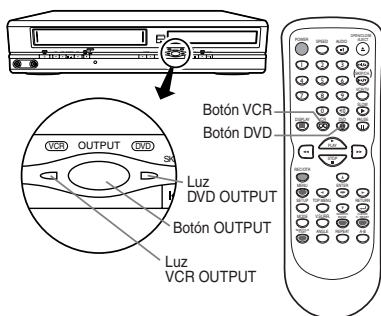

### MODO VCR

Pulse el **botón VCR** en el mando a distancia. (Compruebe que está encendida la luz VCR OUTPUT.)

### MODO DVD

Pulse el **botón DVD** en el mando a distancia. (Compruebe que está encendida la luz DVD OUTPUT.)

### Nota

- Si pulsa sólo el **botón OUTPUT** en el panel frontal NO conmuta el modo del mando a distancia. DEBE seleccionar también el modo correcto en el mando a distancia.

## 4 Activación de la unidad por primera vez

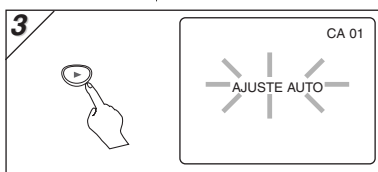
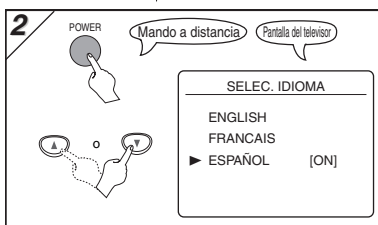
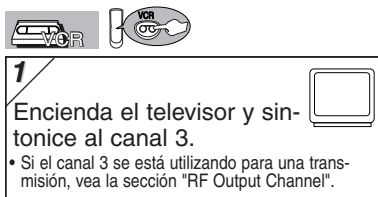

Conecta el cable de la caja de canales de cable o la caja de satélite en la toma ANT IN de DVD/VCR?

**Si** Pulse el botón MENU para salir.

**No** Espere unos minutos.

Después del escaneo

- El sintonizador se detiene en el canal memorizado más abajo.
- Puede seleccionar sólo los canales memorizados en esta unidad con los botones CHANNEL.

## 5 Ajuste del reloj

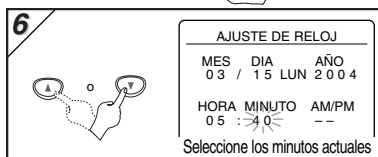
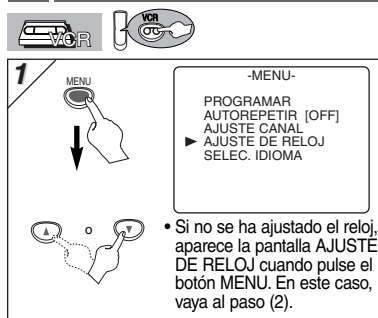

8 Para salir de la pantalla AJUSTE DE RELOJ.

## 6 Reproducción de la grabadora de vídeo

Antes: Encienda el televisor y cambie al canal 3.

- Si el canal 3 se está utilizando para una transmisión, vea la sección "RF Output Channel".

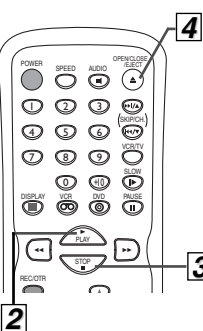
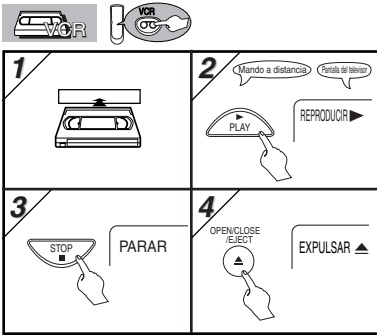

## 7 Reproducción de DVD/CD

Antes: Encienda el televisor, amplificador y otros equipos que puedan estar conectados a esta unidad. Asegúrese que el televisor y el sintonizador de audio (de venta en los comercios) están en el canal correcto.

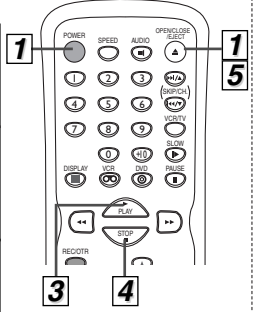
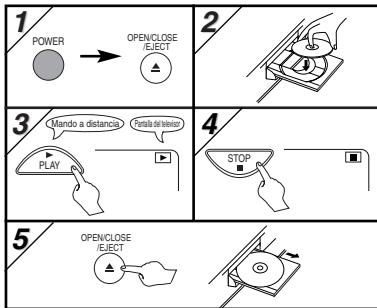

## 8 Mando a distancia

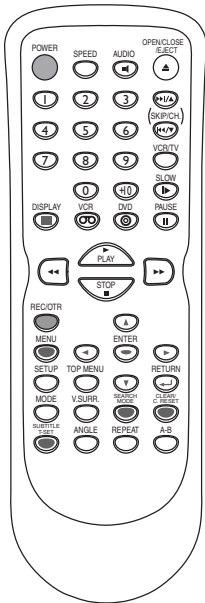

Botón (Orden alfabético)	Disco/cinta	Modo DVD	Modo de grabadora de vídeo
1-6	• Para seleccionar directamente el capítulo o el título.	• Para seleccionar directamente la canción.	• Para seleccionar el canal. El botón +10 no tiene efecto en el modo de grabadora de vídeo.
7-9	• Para buscar en avance/retroceso en un disco. • Para empezar la reproducción en avance/retroceso lento durante el modo de pausa.	• Para buscar en avance/retroceso en un disco.	• Para el avance/retroceso de una cinta.
0	• Para mover el cursor y determinar su posición.	• Para mover el curso y determinar su posición.	• Para seleccionar un ítem en el menú de la grabadora de vídeo. • Para avanzar al siguiente menú de la grabadora de vídeo. • Para volver un paso durante el ajuste del reloj y temporizador.
10	• Para repetir entre los puntos A y B elegidos	• Para repetir entre los puntos A y B elegidos.	—
11	• Para seleccionar los ángulos de la cámara en un disco.	—	—
12	• Para seleccionar el idioma de audio en un disco.	• Para seleccionar ESTÉREO, L-CH o R-CH.	—
13	• Para borrar los marcadores. • Para borrar los números entrados incorrectamente.	• Para borrar los marcadores. • Para retirar el N° de estado en la entrada de programa. • Para borrar los números entrados incorrectamente.	• Para salir del menú de la grabadora de vídeo. • Para reponer el contador de cinta.
14	• Para indicar el modo de disco actual.	• Para indicar el modo de disco actual.	• Para indicar la hora actual, contador de cinta y canal.
15	• Para seleccionar el modo de salida de DVD. • Para activar el mando a distancia en el modo DVD.	• Para seleccionar el modo de salida de DVD. • Para activar el mando a distancia en el modo DVD.	—
16	• Para llamar el menú en un disco.	—	• Para llamar el menú de la grabadora de vídeo.
17	• Para activar/desactivar el nivel del negro.	• Para disponer el orden de reproducción o la reproducción aleatoria.	—
18	• Para abrir o cerrar la bandeja del disco.	• Para abrir o cerrar la bandeja del disco.	• Para expulsar el videocasete de las grabadoras de vídeo.
19	• Para hacer una pausa de reproducción del disco. • Para avanzar la reproducción un cuadro a la vez.	• Para hacer una pausa en la reproducción del disco.	• Para hacer una pausa de la reproducción o grabación de la cinta. • Para avanzar la reproducción un cuadro a la vez.
20	• Para empezar la reproducción del disco.	• Para empezar la reproducción del disco.	• Para empezar la reproducción de la cinta.
21	• Para activar o desactivar la unidad.	• Para activar o desactivar la unidad.	• Para activar o desactivar la unidad.
22	—	—	• Para empezar una grabación.
23	• Para reproducir repetidamente un capítulo o título.	• Para reproducir repetidamente una canción o disco.	—
24	• Para volver a la operación previa en el menú de programación de DVD.	• Para volver a la operación previa en el menú de programación de DVD.	—
25	• Para buscar un capítulo, título u hora. • Para volver rápidamente a un lugar o disco. • Buscar los marcadores.	• Para buscar una canción. • Para buscar la hora. • Para volver rápidamente a un lugar o disco. • Buscar los marcadores.	• Para llamar el menú de búsqueda de índice u hora.
26	• Para llamar el menú de programación de DVD.	• Para llamar el menú de programación de DVD.	—
27	• Para saltar capítulos	• Para saltar canciones.	• Para cambiar de canal. • Para ajustar manualmente el seguimiento durante la reproducción.
28	—	—	• Para ver la cinta en cámara lenta.
29	—	—	• Para seleccionar la velocidad de grabación.
30	• Para parar la grabación.	• Para parar la grabación.	• Para parar la reproducción o grabación.
31	• Para seleccionar subtítulos en un disco.	—	• Para poner la grabadora de vídeo en el modo de espera para una grabación con temporizador.
32	• Para llamar el menú superior en un disco.	—	—
33	—	—	• Para seleccionar el modo de salida de la grabadora de vídeo. • Para activar el mando a distancia en el modo de la grabadora de vídeo.
34	• Para seleccionar la posición de DVD o posición del televisor.	• Para seleccionar la posición de CD o la posición del televisor.	• Para seleccionar la posición de la grabadora de vídeo o posición del televisor.
35	• Para activar/desactivar el envoltente virtual.	• Para activar/desactivar el envoltente virtual.	—

# Quick Use Guide

## 1 Connections

Please refer to "Basic TV Connection" on the front page before you use this unit.

### RF Output Channel

If channel 3 is already occupied for broadcasting,

- 1) Set your TV to channel 4.
- 2) Insert a pre-recorded tape into this unit.
- 3) Press the OUTPUT button on the DVD/VCR so that the VCR OUTPUT light is lit.
  - If noise appears on the TV screen, press the VCR/TV button on the remote control.
- 4) Press the PLAY button once.
- 5) After a few seconds, press the PLAY button on the DVD/VCR for 3 seconds.
  - The RF output channel will change to channel 4 from channel 3 and you will see a playback picture.
  - When a picture does not appear on the TV screen, repeat step [4].
- 6) Press the STOP button to stop playback.

## 2 Installing the Batteries for the Remote Control



## 3 VCR/DVD Switching

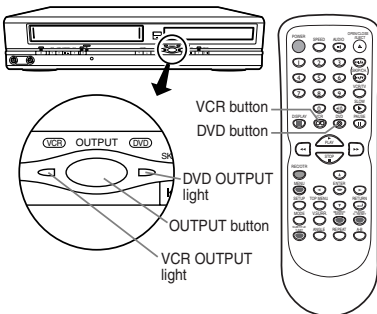

### VCR MODE

Press the **VCR button** on the remote control.  
(Verify that the VCR OUTPUT light is lit.)

### DVD MODE

Press the **DVD button** on the remote control.  
(Verify that the DVD OUTPUT light is lit.)

### Note

- Pressing only the **OUTPUT button** on the front panel DOES NOT switch the mode of the remote control. You MUST select the correct mode on the remote control.

## 4 Turn on the unit for the first time

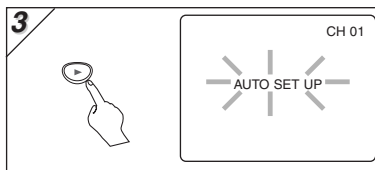
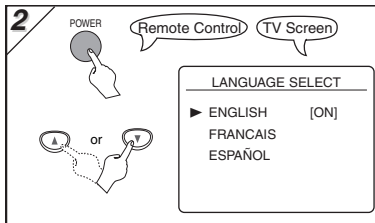
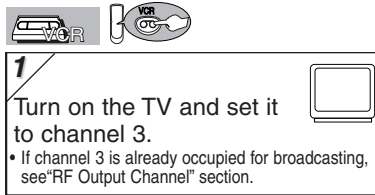

Do you connect the cable from the cable box or the satellite box to the DVD/VCR's ANT IN jack?

**Yes** Press the **MENU** button to exit

**No** Please wait for a few minutes. After scanning...

- The tuner stops on the lowest memorized channel.
- You can select only the channels memorized in this unit by using the CHANNEL buttons.

## 5 Clock Set Up

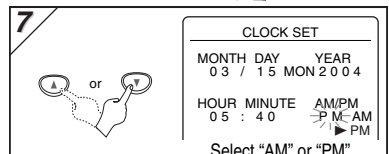
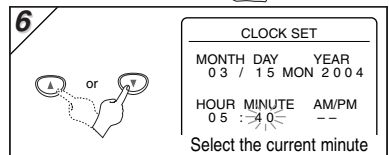
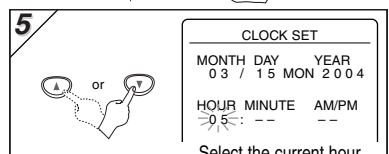
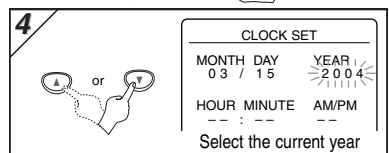
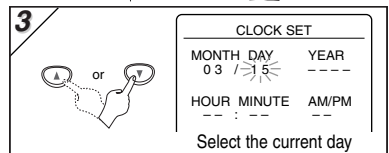
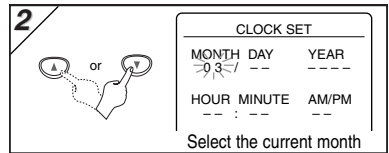
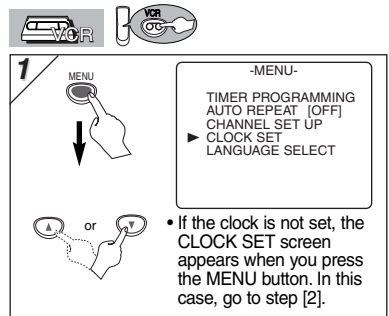

8 To exit the **CLOCK SET** screen.

# Quick Use Guide

## 6 VCR Playback

Before: Turn on the TV and set it to channel 3.

- If channel 3 is already occupied for broadcasting, see "RF Output Channel" section.

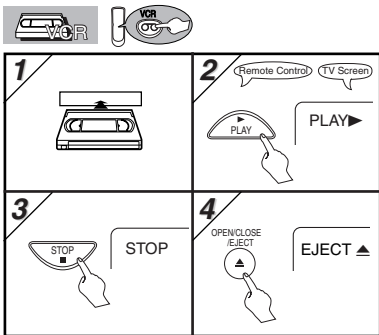

## 7 DVD/CD Playback

Before: Turn on the TV, amplifier and any other components which are connected to this unit. Make sure the TV and audio receiver (commercially available) are set to the correct channel.

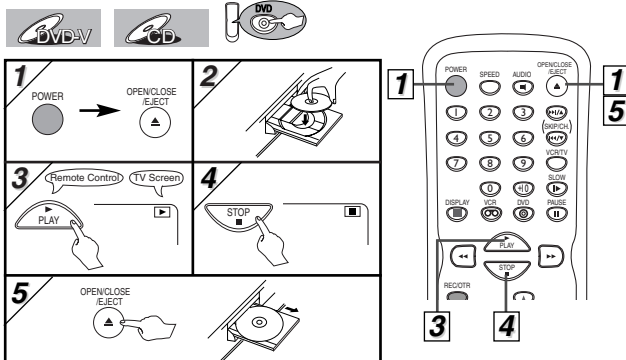

## 8 Remote Control

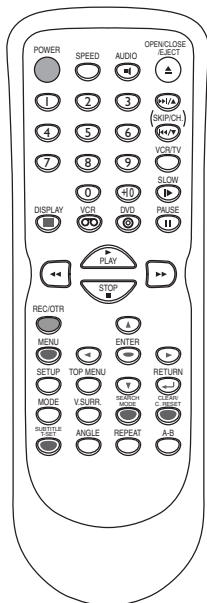

Button (Alphabetical order)	Disc/Tape	DVD mode	VCR mode
1 2 3 4 5 6 7 8 9 0 10 11 12		• To select chapter or title directly.	• To select channel. • The +10 button has no effect in VCR mode.
← →		• To search forward/backward through a disc. • To begin slow forward/reverse playback during the pause mode.	• To forward/backward a tape.
ENTER		• To move the cursor and determine its position.	• To select an item on the VCR Menu. • To advance to the next VCR Menu. • To go back one step during clock and timer setting.
A-B		• To repeat between your chosen point A and B.	—
ANGLE		• To select camera angles on a disc.	—
AUDIO		• To select audio languages on a disc.	—
CLEAR		• To clear the markers. • To clear the numbers entered incorrectly.	• To exit the VCR Menu. • To reset the tape counter.
DISPLAY		• To display the current disc mode.	• To display the current time, tape counter, and channel.
DVD		• To select the DVD output mode. • To activate the remote control in DVD mode.	—
MENU		• To call up the Menu on a disc.	• To call up the VCR Menu.
MODE		• To set black level on/off.	—
OPEN/CLOSE/EJECT		• To open or close the disc tray.	• To eject the video cassette from the VCR.
PAUSE		• To pause disc playback. • To advance playback one frame at a time.	• To pause tape playback or recording. • To advance playback one frame at a time.
PLAY		• To begin disc playback.	• To begin tape playback.
POWER		• To turn the unit on or off.	• To turn the unit on or off.
REC/OTR		—	• To start a recording.
REPEAT		• To play a chapter or title repeatedly.	—
RETURN		• To return to the previous operation on the DVD setup menu.	• To return to the previous operation on the DVD setup menu.
SEARCH		• To search chapter, title or time. • To rapidly return to a location of disc. • Search the markers.	• To call up the index or time search menu.
SETUP		• To call up the DVD setup menu.	• To call up the DVD setup menu.
SKIPCH. SKIPCH.		• To skip chapters.	• To skip tracks.
SLOW		—	• To change channels. • To adjust the tracking manually during playback.
SPEED		—	• To view the tape in slow motion. • To select the recording speed.
STOP		• To stop playback.	• To stop playback or recording.
SUBTITLE		• To select subtitles on a disc.	• To put the VCR into standby mode for a timer recording.
TOP MENU		• To call up the Top Menu on a disc.	—
VCR		—	• To select the VCR output mode. • To activate the remote control in VCR mode.
VCR/TV		• To select DVD position or TV position.	• To select VCR position or TV position.
V.SURR		• To set virtual surround on/off.	—